

Model 420 Series

Forma Orbital Shaker *

Operating and Maintenance Manual 7000420 Rev. 7



* Triple counter-balanced, single eccentric drive mechanism (U.S. Patent #5,558,437)

* Test tube rack (U.S. Patent #5,632,388)

MANUAL NUMBER 7000420

--	--	11/15/06	Clarified that platforms are ordered separately (pack list)	ccs
7	22245/OS284	3/26/04	Updated timer specifications to 5 minute increments	ccs
--	OS-279	2/19/04	Added unit specific electrical schematic, no Model 4500 Series	ccs
--	--	6/25/03	Inserted platform installation section, removed erroneously	ccs
6	20194	7/3/01	Changed ferrite installation and updated EMC standard	aks
5	19305/OS-217	10/21/00	Added platform stalled and check fuse alarm messages	ccs
4	--	10/2/00	Quark format	ccs
3	18544/OS-202	10/19/99	Added power fail time delay, chg'd check belt alarm message clear	ccs
2	18404	7/9/99	Removed drive mechanism shipping bracket, Section 2.8	ccs
--	17928/SI-7405	6/8/99	Added universal test tube holder 600088	ccp
1	SI-7348	2/10/99	Updated parts list and schematics (board chgs) per R. Bruker	deg
REV	ECR/ECN	DATE	DESCRIPTION	By



Important Read this instruction manual. Failure to read, understand and follow the instructions in this manual may result in damage to the unit, injury to operating personnel, and poor equipment performance. ▲

Caution All internal adjustments and maintenance must be performed by qualified service personnel. ▲

Warning Model 420 Orbital Shaker may be used to process non-flammable materials only! ▲

Warning Grounding circuit continuity is vital for the safe operation of this shaker. Never operate this unit with the grounding circuit disconnected. ▲

Material in this manual is for information purposes only. The contents and the product it describes are subject to change without notice. Thermo Fisher Scientific makes no representations or warranties with respect to this manual. In no event shall Thermo be held liable for any damages, direct or incidental, arising out of or related to the use of this manual.

©1999 Thermo Fisher Scientific. All rights reserved.



Important operating and/or maintenance instructions. Read the accompanying text carefully.



Potential electrical hazards. Only qualified persons should perform procedures associated with this symbol.



Equipment being maintained or serviced must be turned off and locked off to prevent possible injury.



Marking of electrical and electronic equipment, which applies to electrical and electronic equipment falling under the Directive 2002/96/EC (WEEE) and the equipment that has been put on the market after 13 August 2005.



This product is required to comply with the European Union's Waste Electrical & Electronic Equipment (WEEE) Directive 2002/96/EC. It is marked with the WEEE symbol. Thermo Fisher Scientific has contracted with one or more recycling/disposal companies in each EU Member State European Country, and this product should be disposed of or recycled through them. Further information on Thermo's compliance with this directive, the recyclers in your country and information on Thermo products will be available at www.thermofisher.com.

- ✓ Always use the proper protective equipment (clothing, gloves, goggles, etc.)
- ✓ Always dissipate extreme cold or heat and wear protective clothing.
- ✓ Always follow good hygiene practices.
- ✓ Each individual is responsible for his or her own safety.

Do You Need Information or Assistance on Thermo Fisher Scientific Products?

If you do, please contact us 8:00 a.m. to 6:00 p.m. (Eastern Time) at:

1-740-373-4763

1-888-213-1790

1-740-373-4189

<http://www.thermo.com/forma>

services.controlenv@thermo.com

Direct

Toll Free, U.S. and Canada

FAX

Internet Worldwide Web Home Page

Service E-Mail Address

Our **Sales Support** staff can provide information on pricing and give you quotations. We can take your order and provide delivery information on major equipment items or make arrangements to have your local sales representative contact you. Our products are listed on the Internet and we can be contacted through our Internet home page.

Our **Service Support** staff can supply technical information about proper setup, operation or troubleshooting of your equipment. We can fill your needs for spare or replacement parts or provide you with on-site service. We can also provide you with a quotation on our Extended Warranty for your Thermo products.

Whatever Thermo products you need or use, we will be happy to discuss your applications. If you are experiencing technical problems, working together, we will help you locate the problem and, chances are, correct it yourself...over the telephone without a service call.

When more extensive service is necessary, we will assist you with direct factory trained technicians or a qualified service organization for on-the-spot repair. If your service need is covered by the warranty, we will arrange for the unit to be repaired at our expense and to your satisfaction.

Regardless of your needs, our professional telephone technicians are available to assist you Monday through Friday from 8:00 a.m. to 6:00 p.m. Eastern Time. Please contact us by telephone or fax. If you wish to write, our mailing address is:

Thermo Fisher Scientific Inc
Controlled Environment Equipment
401 Millcreek Road, Box 649
Marietta, OH 45750

International customers, please contact your local Thermo distributor.

Table of Contents

Section 1	Installation	1-1
	Remove the Pallet Shipping Brackets	1-1
	Location	1-1
	Special Ventilation Requirements	1-2
	Power Module	1-2
	Electrical Requirements	1-2
	Check Operating Voltage	1-3
	Change Operating Voltage	1-3
	Install the Platform	1-4
	Assemble the Flask Clips	1-5
	Install the Flask Clips	1-6
	Install the Test Tube Holders	1-6
	RS-232 Interface Connector	1-7
	Connect the Remote Alarm	1-10
Section 2	Operation	2-1
	Control Panel Operation	2-2
	Quick Start-Up	2-2
	Factory (Default) Settings	2-3
	Change Temperature, Speed, Time Settings	2-3
	Change Temperature	2-4
	Change RPM	2-4
	Change Time	2-4
	Change from Hold to Countdown	2-5
	The Shaker Alarms	2-5
	Overtemp Shutdown	2-6
	Cycle Complete	2-6
	Power Failure	2-7
	RPM Tracking	2-7
	Check Belt	2-8
	Sensor Fault	2-8
	Temperature High or Low	2-8
	Platform Stalled	2-9
	Check Fuse	2-9
	Change Shaker Configuration	2-9
	Turn Audible Alarm On/Off	2-10
	Set Alarm Limits	2-11
	Calibrate Speed and Temperature	2-13

Section 2 (continued)	Calibrate RPM	2-14
	Calibrate the Temperature	2-14
	Remote Alarm System	2-15
	Cycle Complete	2-15
	Power Failure	2-16
	RPM Tracking	2-16
	Check Belt	2-16
	Sensor Fault	2-17
	Temperature High or Low	2-17
	View Total Operating Hours	2-17
	Heat %	2-18
	Software Version	2-19
	Temperature Sensor Readings	2-19
	Menu Map	2-20
	Alarm Messages	2-21
	Preventive Maintenance	2-23
Section 3	Maintenance	3-1
	Platform and Cabinet	3-1
	Control Panel	3-1
	Clean-up After a Spill	3-1
	Test Overtemperature Alarm	3-2
Section 4	Service	4-1
	Alarms and Alarm Conditions	4-1
	Adjust Drive V-belt Tension	4-2
	Install a New Drive V-belt	4-3
	Troubleshoot/Replace Circuit Boards	4-4
	Electronics Panel	4-4
	Output Board	4-6
	Motor Driver Circuit Board	4-6
	Manual Reset Thermostat	4-7
	Temperature Sensors	4-7
	Drive Belt Sensor	4-7
	Spare Fuses	4-8
	Clean Inside Cabinet After a Major Spill	4-8
Section 5	Specifications	5-1
Section 6	Parts List	6-1
Section 7	Electrical Schematics	7-1
Section 8	Warranty Information	8-1

Section 1 Installation

The Model 420 Orbital Incubator Shaker is supplied with the following materials:

- 1 - T-handle 5/32" hex socket wrench
- 2 - Platform alignment studs 1/4-20
- 6 - Grade 8, 5/32" hex socket flat head screws (provided with platform)
- 1 - Screwdriver for flask clip installation and removal
- 1 - Line cord set
- 2 - Cable mountable ferrites for remote alarm and RS-232 connections
- 1 - Platform (if applicable, must be ordered separately)

Remove the Pallet Shipping Brackets

Warning This shaker is heavy! The net weight of Model 420 is 185 lbs. (83.9kg). Have assistance available when moving it. Place this unit on a support surface that will accommodate the weight and operating motion of this shaker. ▲

The Orbital Shaker is secured to its shipping pallet with two brackets, one on each side of the frame (Figure 1-1). A 7/16" wrench is required to remove the brackets from the pallet. Remove the shipping brackets from the shaker by unhooking them from the shaker frame.

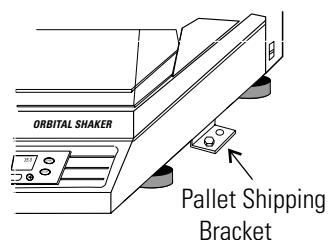

Figure 1-1. Bracket

Location

Install the shaker on a sturdy table or bench. The support structure must be able to accommodate both the weight and operating motion of the shaker. The shaker can also be placed under a bench or in a “knee well.”

Special Ventilation Requirements

If the shaker is to be operated at a temperature 5° to 10°C above ambient, the circular vent at the rear of the cabinet must be 1” from the wall and the rear vent must be fully opened by turning the Phillips screw clockwise. Refer to Figure 1-2.

If operating temperatures are more than 10° above ambient, the rear vent must remain closed (fully counterclockwise).

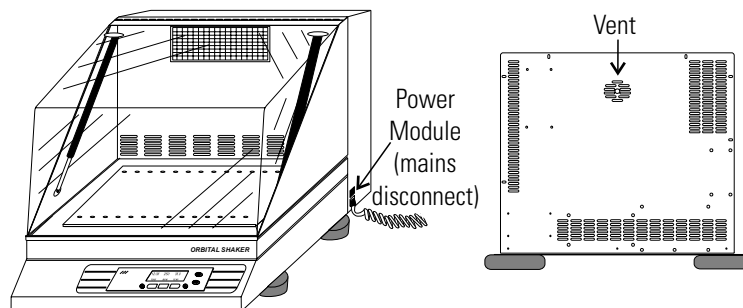

Figure 1-2. Vents

Power Module

A power module (Figure 1-3) located on the right side of the shaker contains the On/Off power switch, two fuses, and the line cord receptacle. It is the mains disconnect for the unit.

Figure 1-4 lists the voltage, rating and part numbers of the power module fuses.

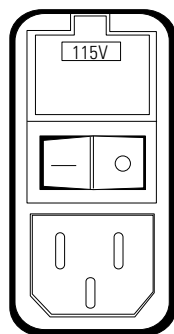
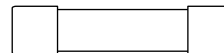

Figure 1-3. Power Module

115V fuse 10A P/N 285633



230V fuse 4A P/N 230165

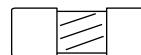

Figure 1-4. Fuses

Electrical Requirements

The electrical power requirements of the Model 420 Shaker are:

115VAC, 50/60 Hz, 1 PH, 6.5 FLA

230VAC, 50/60 Hz, 1 PH, 3.2 FLA

Check Operating Voltage

A small window in the power module above the On/Off switch shows the shaker's operating power configuration. The voltage shown in this window must match the line voltage available where the shaker will be installed. Figure 1-3 shows the shaker configured for 115 volts.

If the electrical service does not match the voltage shown, the power module must be changed before the unit is plugged in and turned on.

Caution Do not plug the shaker in or try to operate it if the line voltage does not match the configuration voltage shown on the power module. ▲

Change Operating Voltage

Remove the line cord if it is plugged in, then change the operating voltage by following the illustrations in Figures 1-5 through 1-7.

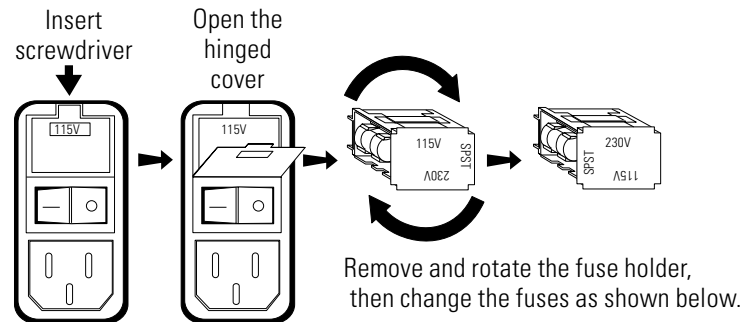

Figure 1-5. Remove and Rotate Fuseholder

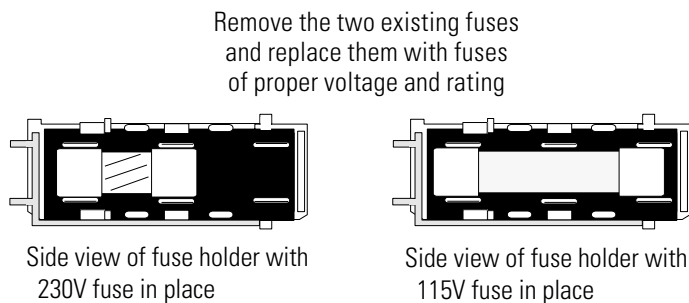

Figure 1-6. Replace Fuses

When the shaker is completely assembled, make sure the power switch is turned off and plug the line cord into the power module.

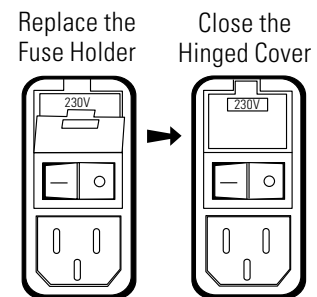

Figure 1-7. Re-install

Install the Platform

Caution Install the shaker platform before plugging in or attempting to operate the unit. ▲

The Model 420 Shaker/Incubator accepts a heavy-duty, 18" (wide) x 17-3/4" (front to back), 5/16" aluminum platform. The shaker platform is attached to the orbital mechanism with six 1/4-20 x 3/4" long hex socket flat head screws, Grade 8. These screws are hardened and should not be replaced with any other screw type. A 5/32" hex socket wrench is included with the shaker to attach the platform. Figure 1-8 identifies the hex socket wrench and hex socket flat head screws.

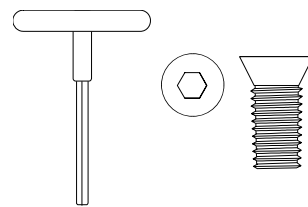

Figure 1-8. Included Wrench

Caution Do not attempt to use a Phillips head screwdriver! ▲

To install the shaker platform:

1. Insert the two 1/4-20 alignment pins into the two mounting holes identified in Figures 1-9 and 1-10.

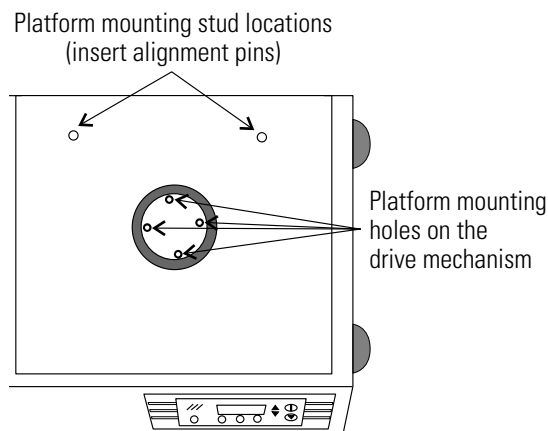

Figure 1-9. Mounting Holes and Pin

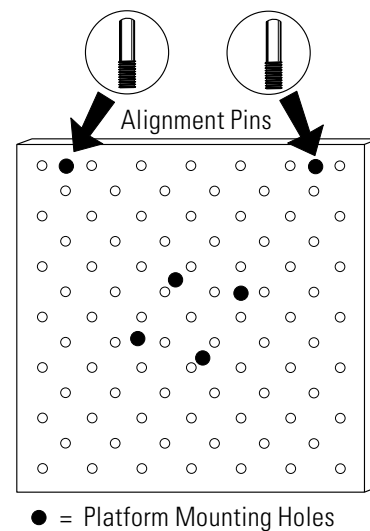

Figure 1-10. Mounting Holes

2. Rotate the drive mechanism until the four mounting holes approximately match the holes in the platform.
3. Place the platform onto the shaker and over the alignment pins.
4. Move the platform in an orbital motion until one or more of the center mounting holes are located.

Install the Platform cont.

5. Insert the hex socket head screws as the four holes are located. Do not tighten the screws.
6. Remove the 1/4-20 alignment pins and replace them with the remaining two hex socket screws.
7. Seat all screws very tightly, using the T-handle wrench. If a torque wrench is available, tighten these screws at 120 in./lbs. Check these screws monthly if the unit is operated at or near maximum RPM.

Caution Use only the included hex socket screws and T-handle wrench to fasten the platform. If a torque wrench is available, torque the screws to 120 in./lbs. The platform screws should be checked monthly if the unit is operated at or near maximum RPM. ▲

Assemble the Flask Clips

Each Flask Clip, up to 1 liter in size, is supplied with a metal spring that must be installed onto the clip. Two-liter flask clips are supplied with two springs.

For flask clips through 500 ml, insert the end of each spring into the holes on the top of the clip leg as shown in Figure 1-11. One liter and larger flask clips require the spring ends to be hooked together as shown in Figure 1-12.

The spring ends on the two-liter flask clip are also hooked together, but require the rubber spring tubes to be installed between the clip legs (Figure 1-11). The second spring and spring tubes are placed around the base of the clip after it has been installed onto the platform.

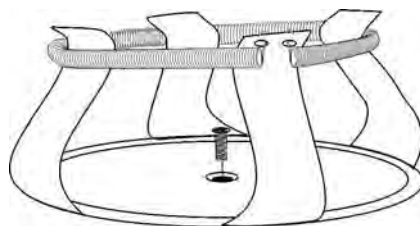

Figure 1-11. Clip Mounting Screw

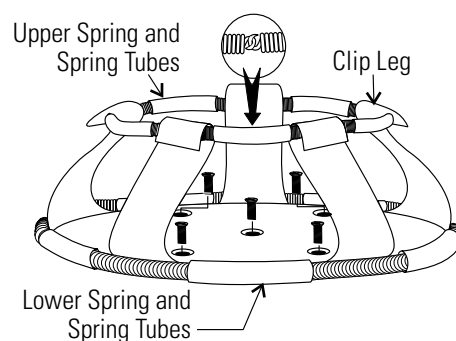

Figure 1-12. Clip Components

Install the Flask Clips

The Model 420 will accommodate glassware in numbers and sizes from forty-nine 25 ml flasks to six, 2-liter flasks.

Flask clips can be attached anywhere on the shaker platform. The counterbalanced design of these shakers accommodates even an unbalanced load. The flask clips are supplied with the proper screws and are attached to the platform with a standard Phillips screwdriver or with the screwdriver provided with the unit.

Table 1-1. Platform Flask Clip Capacity

Platform Number	No. of Clips	Flask Size	Springs/Clip	Screws/Clip
238010	49	25 ml	1	1
238011	49	50 ml	1	1
238012	25	125 ml	1	1
238013	18	250/300 ml	1 (w/1 lg. pad)	1
238014	16	500 ml	1	1
238015	8	1 L	1	5
238016	5	2 L	2 (w/10 tubes)	5

Figures 1-11 and 1-12 illustrate the installation of the flask clips. Note that 1-liter and 2-liter flask clips use five screws. The 250/300-flask clip has an adhesive-backed flask cushion pad that is installed on the flat base of the clip body. A hole is provided in the pad for the mounting screw. Refer to Figure 1-11.

Install the Test Tube Holders

Accessory Test Tube Racks and Test Tube Rack Holders are available in four sizes and are listed in Table 1-2. All the Test Tube Rack Holders are adjustable into seven positions, swinging and locking at 15°, 30° and 45° in either direction. Figure 1-13 illustrates the Test Tube Rack Holder with rack in place.

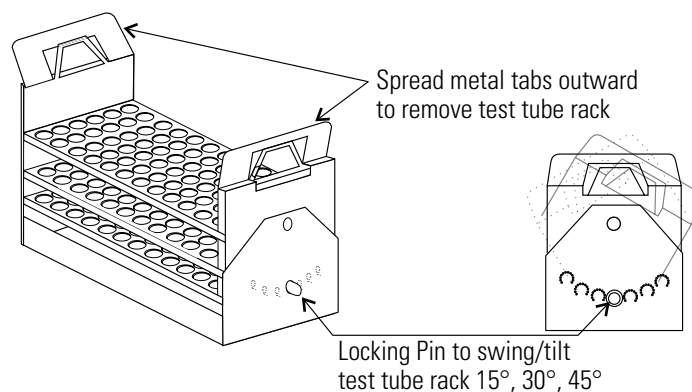

Figure 1-13. Holder with Rack

Install the Test Tube Holders (cont.)

To remove the rack, spread the metal tabs on either end of the holder and lift out the plastic Test Tube Rack.

To install the Test Tube Rack Holder onto the shaker platform, remove the rack and rotate the swing-bed of the holder 90° by pulling the knobs of the locking pins on either end of the holder outward. The pins are locked outward by turning the knob 1/4-turn (Figure 1-14). Attach the tray to the platform with the screws provided.

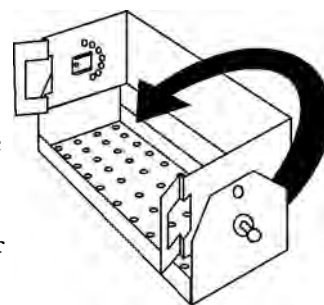

Figure 1-14. Holder with Rack Removed

Table 1-2. Accessory Test Tube Racks and Adjustable-Angle Rack Holders

Part No.	Description
950040	Test Tube Rack, 10-13 mm size
950060	Test Tube Rack, 16-20 mm size
600074	Test Tube Rack, 21-25 mm size
600075	Test Tube Rack, 26-30 mm size
600076	Adjustable-Angle Test Tube Holder with Rack, 10-13 mm
600077	Adjustable-Angle Test Tube Holder with Rack, 16-20 mm
600078	Adjustable-Angle Test Tube Holder with Rack, 21-25 mm
600079	Adjustable-Angle Test Tube Holder with Rack, 26-30 mm
600088	Universal Adjustable-Angle Test Tube Holder. 10-25 mm
600089	2-Tier Micro-Plate Rack
600090	3-Tier Micro-Plate Rack
194024	#10-24 Pan Head Phillips Screws for mounting test tube holders to platform

RS-232 Interface Connector

The Model 420 Orbital Shaker is equipped with an RS-232 Serial Communication Interface for the remote transmission of data. A RJ-11 telephone style connector is located on the left side of the incubator. A cable with RJ-11 plugs and an RJ-11 to DB-25 adapter are required. Refer to Figure 1-16 for pin identification and Figure 1-17 for connector locations on the shaker side panel. A cable mountable ferrite is included for installation of the RJ-11 cable. Loop and snap (Figure 1-15) the ferrite over the cable to reduce electro-magnetic emissions from the unit. Attach the ferrite device close to the unit.

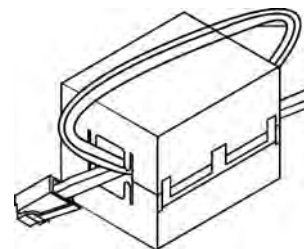

Figure 1-15. Ferrite

RS-232 Interface Connector (cont.)

The RS-232 data is a formatted “dumb terminal”, which permits interfacing with either a computer or a serial printer.

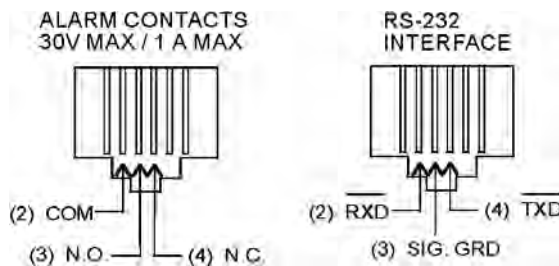

Figure 1-16. Remote Alarm and RS-232 Connectors

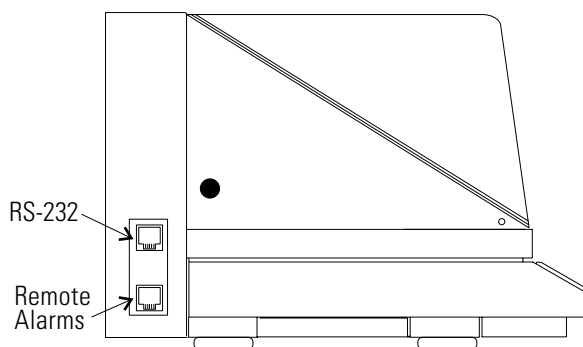

Figure 1-17. Connector Location

Three wires are used for the RS-232 interface:

1. Transmit data (/TXD) - pin 2 DB-25 connections
2. Receive data (/RXD) - pin 3 DB-25 connections
3. Signal ground (GND) - pin 7 DB-25 connections

The data format is:

Baud1200 (9600 baud with jumper at J1,
 pins 3 and 4 on the Main Control Board)
 Data bits8 (7 bit ASCII with leading zero)
 Start bits1
 Stop bits1
 Paritynone

RS-232 Interface Connector (cont.)

The data transfer sequence is transmitted in the following format. X refers to the numerical time, RPM and temperature.

(NUL)XX:XX(H)(SP)(SP)XXXRPM(SP)(SP)XX.XC(SP)(LF)(CR)(EOT)

NUL	Null character (0)
SP	Space
LF	Line feed
CR	Carriage return
EOT	End of text (4)
H	Hold Mode

The Model 420 transmits time, RPM and temperature information one minute after power is first applied to the unit, then every 60 minutes.

The shaker's microprocessor responds to two ASCII commands from the remote: DC1 (XON), and DC3 (XOFF)

DC1 (17, 11 Hexadecimal)

The shaker will transmit Time, Temperature and RPM data upon receiving "DC1" (XON) and will restart 60 minute interval transmissions if they have been inhibited by a "DC3" (XOFF).

DC3 (19, 13 Hexadecimal)

Receiving a "DC3" (XOFF) from the remote inhibits the shaker from sending serial data indefinitely until a "DC1" (XON) is received.

Connect the Remote Alarm

An internal SPDT relay is provided to monitor alarms and is connected by a RJ-11 (telephone style) jack on the rear of the cabinet. The remote alarm provides NO (normally open) and NC (normally closed) output. Figure 1-16 identifies the pin contacts. Figure 1-17 shows the location of the Remote Alarm Connector.

A modular to modular cable (Stock No. 190388) and an RJ-11 telephone style terminal converter (Stock No. 190392) or equivalent may be used to convert the remote alarm output to a screw terminal connection. Refer to Figure 1-18 below. When using the remote alarm contacts, loop and snap the cable-mountable ferrite over the cable to reduce electro-magnetic emissions from the unit (Figure 1-15). Attach the ferrite device close to the unit.

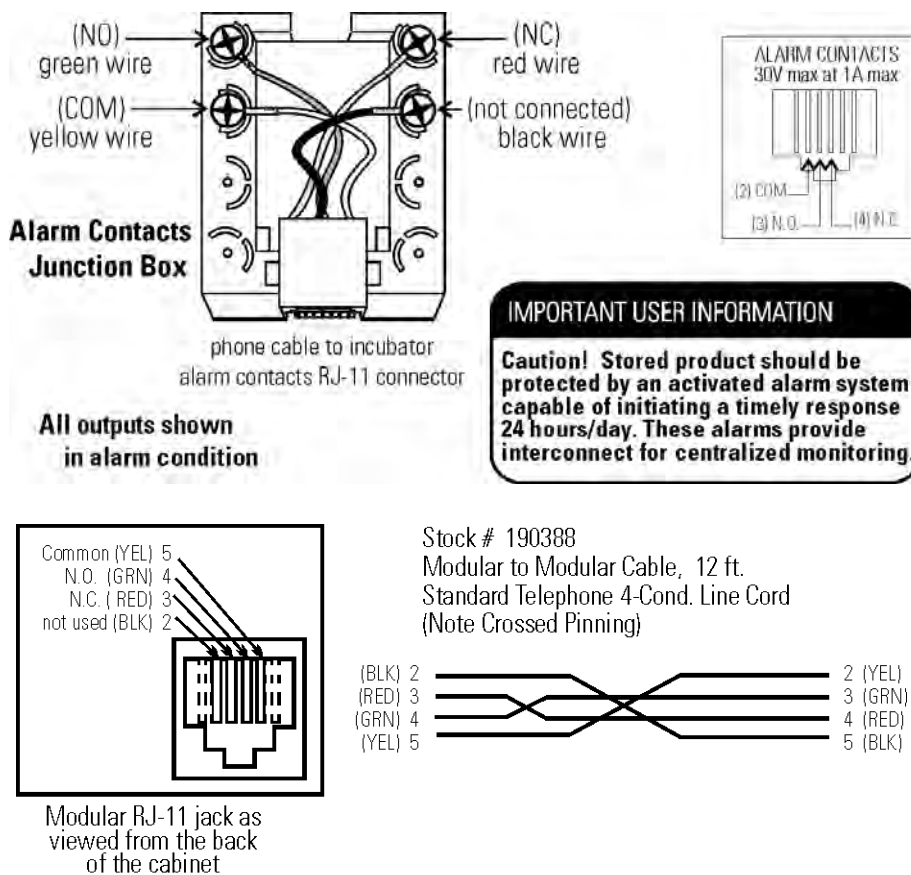

Figure 1-18. Alarm Contacts

Section 2 Operation

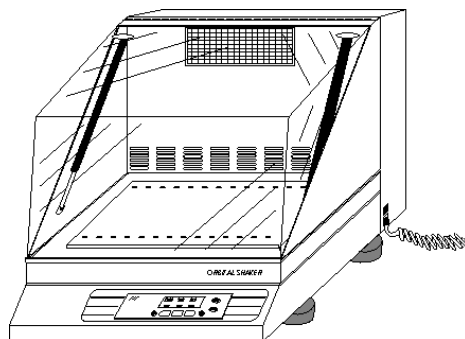

Figure 2-1. Front View

Model 420 is a microprocessor-controlled benchtop orbital shaker designed to accommodate a wide variety of flasks, test tubes and other glassware. The control system is easily programmed and stores the user-defined time, temperature and speed setting which remain in memory even when the shaker is turned off and unplugged.

The computer-based speed controller continuously adjusts for line voltage fluctuations and provides smooth start-ups and consistent RPM control. The circuitry is designed to slowly bring the platform up to speed and down to a stop to prevent liquid splashing from flasks or test tubes. A convenience interlock requires that the lid be closed for the drive motor, circulating fans and heating elements to operate.

- The microprocessor speed control system may take up to one minute to bring the platform up to speed.
- Never leave the shaker unattended when starting it. Make sure all flasks and test tube racks are firmly seated in the clips and check the security of the flask clip and platform attachment screws monthly.
- The lid must be closed to operate the shaker.
- Do not operate the shaker at maximum RPM without a load.

Control Panel Operation

The Model 420 Control Panel has a liquid crystal display and eight operating keys or buttons which are identified by word and symbol. During programming activities, the up and down arrows increase and decrease the numerical values of time, platform speed, or temperature. Pressing and holding either arrow will cause the values to scroll in that direction. Pressing and holding for about five seconds will increase the scrolling speed.

When programming the system configuration, the UP arrow returns the display to the system's Operating Screen showing the Time, RPM and Temperature, while the DOWN arrow advances the display to the next programming screen.

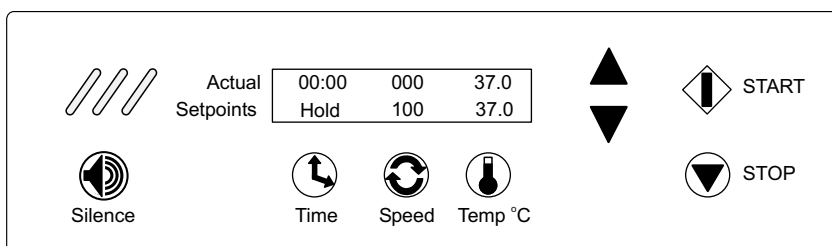

Figure 2-2. Control Panel

The alarm indicator and alarm silence button complete the shaker control panel. When in alarm, the unit sounds an audible warning and flashes the three red indicators. Pressing the Silence button turns off the audible portion of the alarm. However, the three flashing indicators continue to flash until the alarm condition is corrected. The audible warning will sound again in about fifteen minutes if the condition continues.

The alarm features are discussed in more detail in the Configuration section of this manual.

Quick Start-Up

The Model 420 Orbital Shaker may be operated as soon as the platform is installed, the unit is plugged in, and turned on.

Note At power up, the screen at the right briefly appears. ▲

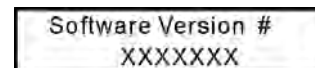

Pressing Start and Stop will operate the shaker at the factory settings shown in Figure 2-2. When starting, the Actual numbers along the top of the liquid crystal display will differ from the Setpoint values shown along the bottom. These numbers will change as the unit begins to operate.

Quick Start-Up (cont.)

Time - With the time set at Hold, the time display in the upper left portion of the screen begins to count upward, showing the total operating hours and minutes. The system resets to 00:00 whenever the unit is stopped and restarted, using the Stop and Start buttons. The unit will not reset if the unit is turned off and on using the power switch, or if the cover is repeatedly opened and closed.

Speed - The Actual speed will display zero RPM's and will gradually rise as the platform begins its motion.

Temperature - The temperature, shown in the upper right portion of the liquid crystal display, will indicate the actual ambient temperature inside the cabinet and will slowly move toward the 37° setpoint.

The values shown in Figure 2-2 are set at the factory and are considered default values. Other factory settings are shown in the table following.

Factory (Default) Settings

Table 3-1. Defaults

Function	Default
Audible Alarm	ON
RPM Tracking Limit (fixed)	5
Temperature Tracking Limit	10°C
Over Temperature Shut-down	83°C - 85°C
All Remote Alarms	ON

To get the most from the shaker's microprocessor-based technology, the Model 420 can be easily programmed to meet the most demanding laboratory requirements. The following sections outline the procedures for changing the settings and for programming the shaker control system.

Change Temperature, Speed, Time Settings

When first turned on or when the shaker is operating, Temperature, Time and RPM values are displayed on the LCD. A typical screen is illustrated in Figure 2-2. For convenience, this is called the Operating Screen throughout these instructions. All programming or setting changes start from this screen.

The instructions to program the Model 420 are written in a step-by-step format. For convenience, the instructions begin and end at the Operating Screen.

Change Temp, Speed, Time Settings (cont.)

Note At any time during programming or changing settings, if no control panel buttons are pressed for about fifteen seconds, the display automatically returns to the Operating Screen, storing any settings made. New settings are also stored immediately when either arrow key is pressed. ▲

Change Temperature

1. Press the button beneath the temperature setpoint (Temp °C). The temperature value will begin to flash.
2. Press the up or down arrows to set the new temperature in 0.1°C increments. Hold either button to scroll.
3. Press the temperature button again to return to the Operating Screen.

Change RPM

1. Press the button beneath the Speed setpoint. The RPM value will begin to flash.
2. Press the up or down arrows to set the new speed in 1 RPM increments. Hold either button to scroll.
3. Press the Speed button again to return to the Operating Screen.

Change Time

The Model 420 manages operating time in two ways:

Hold - When Time is set to Hold, the value shown in the Actual portion of the display represents total operating time and may be reset at the operator's convenience. The shaker will continue to count upwards even if the cover has been repeatedly opened and closed, or turned off and on with the power switch. The Time will, however, reset to 00:00 when the Stop button is pressed and the unit then restarted by pressing the Start button.

Countdown - When the Hold setpoint is changed to countdown entering a time value in hours and minutes, the shaker will operate for that period and automatically shut down. The display will show the total time in the Setpoint segment and the operating time remaining in the Actual part of the display, as the microprocessor counts down to zero.

Change from Hold to Countdown

1. Press the button beneath the Time setpoint. Hold will begin to flash.

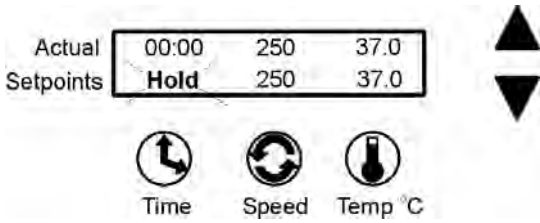

Figure 2-3. Flashing Hold

2. Press either arrow to access the Countdown Time setpoint. The preset time setpoint will begin to flash.
3. Press the up or down arrows to set the desired operating time in five minute increments. Hold either arrow to scroll in that direction.
4. When the desired elapsed time is set (8 hours, 30 minutes in this example), press the Time button to return to the Operating Screen. Pressing the Start button will start the shaker and begin the countdown sequence. When 00:00 is reached, the shaker will automatically shut off and the Cycle Complete alarm will sound.

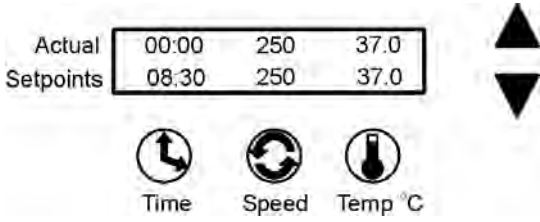

Figure 2-4. Time Set

The Shaker Alarms

The Model 420 Orbital Shaker control system monitors and provides alarms for nine operating parameters.

Parameter	Alarm Message
Overtemp Setpoint Status	Overtemp Shutdown
Cycle Status	Cycle Complete
Loss of Input Power	Power Failure
RPM versus Setpoint	RPM Tracking
Drive Belt Integrity	Check Belt
Temp Sensor Integrity	Sensor Fault
Temp Control Status	Temperature High/Low
Platform Movement Status	Platform Stalled
Motor Fuse Integrity	Check Fuse

The Shaker Alarms (cont.)

Both audible and visual alarm warnings for these nine parameters are provided by the Orbital Shaker. Visual flashing of the three diagonal indicator lights on the control panel, a progression of text messages on the display, and an audible tone alerts the operator that an alarm condition has occurred or currently exists.

For convenience, the audible tone is silenced by pressing the Silence button, but rings back in about 15 minutes. However, the alarm warning indicator lights and alarm messages continue until the alarm condition is corrected by the operator. Then, pressing the Silence button clears the message from the display ('Check Belt' and 'Check Fuse' alarms require the unit to be turned off, then on again to remove the message from the display).

As discussed in the Configuration section of this manual, the audible alarm feature may be turned off to suit operator or laboratory needs.

Refer also to the alarms and corrective actions chart in the Service section of this manual.

Overtemp Shutdown

Overtemp Shutdown alerts the operator that the overtemp setpoint has been exceeded by a few tenths of a degree.

Actual	08:41	250	37.0
Setpoints	Overtemp Shutdown		

The Overtemp Shutdown message displays and the heaters are turned off, but the platform and the blowers continue to operate.

In the alarm state, the audible alarm is silenced by pressing the Silence button, but rings back in about 15 minutes. The screen message and warning lights, however, continue until the fault is corrected. Then, press the Silence button to clear the alarm message.

Cycle Complete

Cycle Complete alerts the operator that the end of the count-down running time has been reached.

Actual	00:00	0	37.0
Setpoints	Cycle Complete		

The Cycle Complete message shown displays and the shaker stops.

Press the Silence button to clear the message from the display screen.

Power Failure

Power Failure alerts the operator that electrical power to the shaker has been interrupted and then restored while it was shaking.

Actual	00:00	0	37.0
Setpoints	Power Failure		

While the system returns to normal operation when power is restored, the alarm message remains and the audible tone continues to sound to alert the operator. Both the display message and the audible tone are cleared by pressing the Silence button.

Note The alarm will not occur if the power failure is less than 15 seconds in duration. ▲

Note If power is interrupted for two hours or more while the Shaker is turned on but not shaking, a Power Fail alarm will occur. The purpose of the alarm in this case is to alert the user that an extended duration power failure occurred during the Hold interval after a timed shaking operation, or during a period of incubation only. This alarm will also occur any time the Shaker is turned on after an extended off period greater than 2 hours (such as when the unit is shipped from the factory, or when it is returned to use after a period of storage). ▲

RPM Tracking

RPM Tracking alerts the operator by either alarm message shown at the left that the platform speed has varied ± 5 RPM.

Actual	08:41	255	37.0
Setpoints	RPM is High		

Actual	08:41	245	37.0
Setpoints	RPM is Low		

Note A two-minute alarm delay is built into the software. ▲

In the alarm state, the audible alarm is silenced by pressing the Silence button, but rings back in about 15 minutes. The screen message and warning lights, however, continue until the fault is corrected. Then, the alarm message is cleared by pressing the Silence button.

Check Belt

Check Belt alerts the operator that the drive belt may have broken or something is slowing or preventing platform movement.

Actual	08:41	0	37.0
Setpoints	Check Belt		

In the alarm state, the audible alarm is silenced by pressing the Silence button, but will ring back in about 30 minutes. The screen message and warning lights, however, will continue until the fault is corrected. Then, the alarm message is cleared by cycling power to the unit OFF, then ON.

Sensor Fault

Sensor Fault alerts the operator that either of the shaker's two temperature sensors have failed. An alarm message similar to those shown below will show which sensor has failed.

Actual	08:41	250	37.0
Setpoints	Main Temp Sensor		

Actual	08:41	250	37.0
Setpoints	Over Temp Sensor		

When in the alarm state, the audible alarm is silenced by pressing the Silence button, but rings back in about 15 minutes if the fault condition persists. The screen message and warning lights continues until the fault is corrected.

When the sensor problem is corrected, the alarm message is cleared by pressing the Silence button.

Temperature High or Low

Temperature High or Temperature Low alerts the operator that the operating temperature of the shaker has risen above or fallen below the programmed temperature tracking limit control point. Therefore, either of the alarm messages shown below will be displayed.

Actual	08:41	250	47.0
Setpoints	Temperature is High		

Actual	08:41	250	27.0
Setpoints	Temperature is Low		

In the alarm state, the audible alarm is silenced by pressing the Silence button, but rings back in about 15 minutes if the fault condition persists. The screen message and warning lights continues until fault is corrected.

After the temperature problem is corrected, press the Silence button to clear the alarm message.

Platform Stalled

Platform Stalled alerts the operator that something is preventing free platform movement. The motor automatically shuts off and the audible alarm, screen message and warning lights are initiated. The motor will attempt restart after approximately 15-20 seconds. The motor will continue to cycle on and off until the obstruction is removed or the unit is turned off. On motor restart, the audible alarm and warning lights are automatically cleared. The screen message will remain until cleared by the operator.

Actual	08:41	0	23.7
Setpoints	Platform Stalled		

Check Fuse

Check Fuse alerts the operator that primary drive motor fuse has blown. The audible alarm, screen message and warning lights are initiated. When the unit is turned on after fuse replacement, all alarm indicators are automatically cleared.

Warning Fuse replacement must be performed by qualified service personnel. See Service section. ▲

Change Shaker Configuration

To access the system Configuration menu, press the down arrow, the up arrow and the Silence button in that sequence.

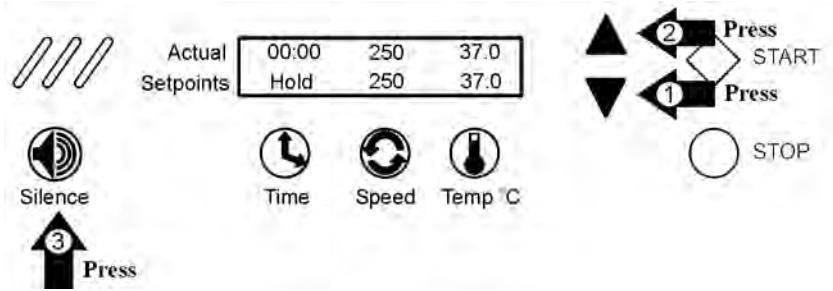

This screen will appear on the display.

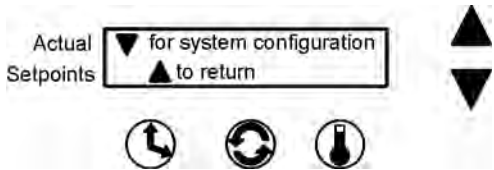

Pressing the down arrow continues with system configuration.

Change Shaker Configuration (cont.)

Pressing the up arrow returns to the Operating Screen.

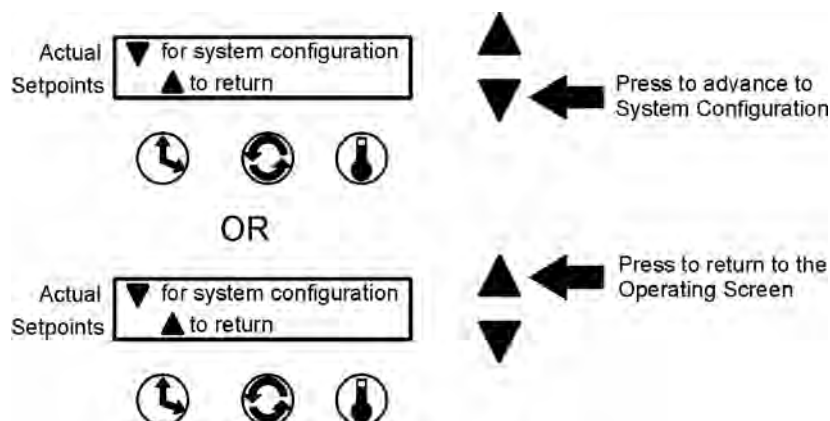

During the following configuration procedures, menu options are given to either modify a setting as it appears in sequence, or scroll past to the next item. If no selection is made by pressing a button or arrow, the display will revert to the Operating Screen in about fifteen seconds. The complete configuration menu is illustrated in the chart at the end of this section.

In these procedures, values and settings for time, temperature, speeds, alarms, and so forth are shown on the display screens. These numbers are for example only and may not be the values encountered when programming your shaker.

Turn Audible Alarm On/Off

Begin by pressing the down arrow, the up arrow, and the Silence button. The screen shown below will appear on the display:

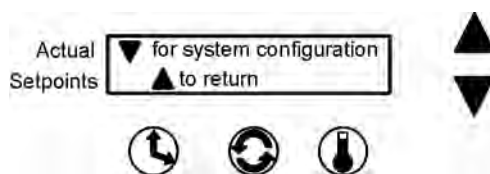
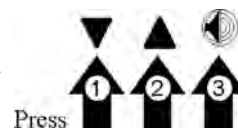

When this screen opens, press the down arrow once.

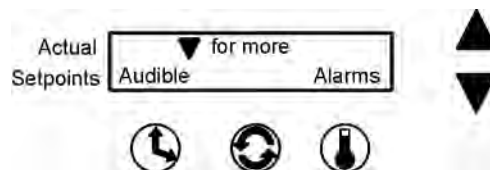

**Turn Audible Alarm On/Off
(continued)**

At this screen, press the Time button beneath Audible. The following screen will appear and the current setting will flash.

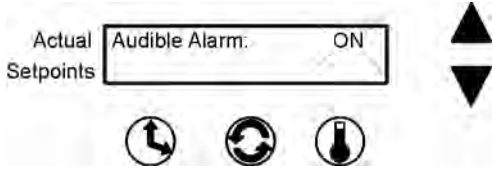

Press the up or down arrow to turn the audible alarm function on or off. Pressing any of the three buttons (Time, Speed, or Temp) will return the display to the previous screen. Not pressing anything for about fifteen seconds returns the display to the Operating Screen.

When the audible alarm is disabled, a warning message is placed in the Setpoint portion of the Operating Screen display as illustrated at the right.

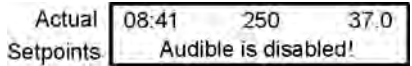

Set Alarm Limits

Two temperature alarms are programmed into the Model 420 orbital shaker: Overtemperature and Tracking limits. To change these values, open the Configuration menu by pressing the down arrow, up arrow, and the Silence button in the sequence shown at the right.

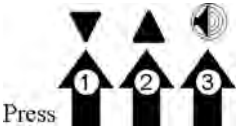

When this screen (below) opens....

Press the down arrow once

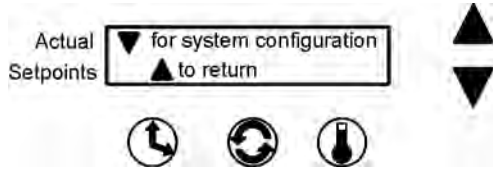

Then press the temperature button beneath Alarms.

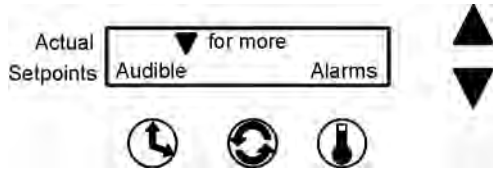

Set Overtemperature Alarm

To change the overtemperature alarm setting, press the Time button beneath Overtemp. The following screen appears and the current over-temperature alarm setting flashes.

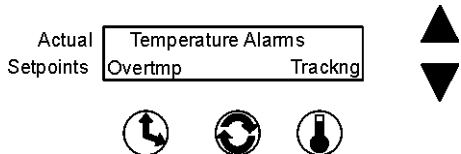

Set Overtemperature Alarm (continued)

Change the temperature setting by pressing the up or down arrow. When set, press the Temperature button to return to the previous screen or press nothing for about fifteen seconds. The display will change to the Operating Screen, saving the new settings into memory.



When the overtemperature setpoint is exceeded by a few tenths of a degree, the control system will shut the shaker down by turning off the heaters.

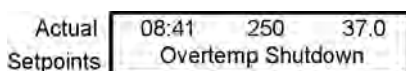

The Overtemp Shutdown warning shown above will be displayed, the warning lights will flash and the audible warning (if not turned off) will sound.

Pressing the Silence button turns off the audible alarm. However, the warning lights continues to flash and the alarm message continues to be displayed until the overtemperature condition is corrected. The audible warning also sounds again in about 15 minutes if the overtemperature condition persists.

When the fault is corrected, press the Silence button to clear the alarm message from the display.

Set Temperature Alarm Tracking Limit

The Temperature Tracking alarm activates whenever the operating temperature goes above or below the setpoint temperature by a predetermined value. This adjustable limit is set at the factory as 10° above and below the temperature setpoint.

Note The above and below limits will always be the same value. ▲

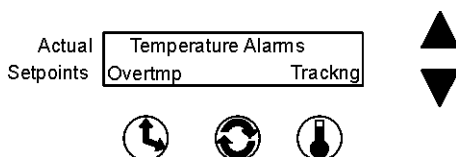

To change this limit, open the configuration menu as in the previous Overtemperature Alarm procedure. From the screen above, press the temperature button beneath Tracking.

Set Temperature Alarm Tracking Limit (continued)

The following screen appears and the present temperature tracking alarm limit setting flashes.

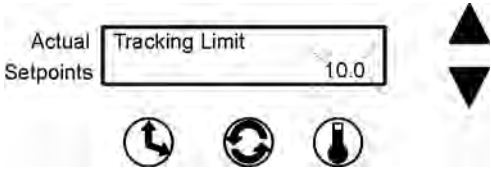

Change the temperature tracking limit by pressing the up or down arrow. When set, press the Temperature button to save the setting and return to the previous screen. If no buttons are pressed for about fifteen seconds, the display changes to the Operating Screen, saving the new setting to memory.

When the chamber temperature rises above or falls below the temperature tracking limit, the appropriate message is displayed, the warning lights flash and the audible warning (if not turned off) sounds.

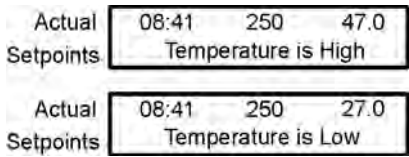

Pressing the Silence button turns off the audible alarm. However, the warning lights continue to flash and the alarm message continues to be displayed until the high or low temperature condition is corrected. The audible warning also sounds again in about fifteen minutes if the over or under temperature tracking condition persists.

When the fault is corrected, press the Silence button to clear the alarm message from the display.

Calibrate Speed and Temperature

From the Operating screen, press the down arrow, up arrow and Silence button in that sequence (shown at the right) to open the Configuration menu.

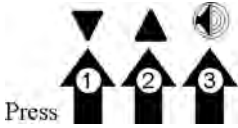

From the screen below, press the down arrow twice to bring up the following screen.

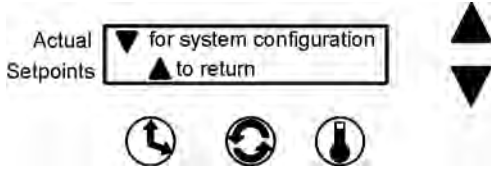

Calibrate RPM

After accessing the Configuration menu (above), press the Speed button beneath RPM.

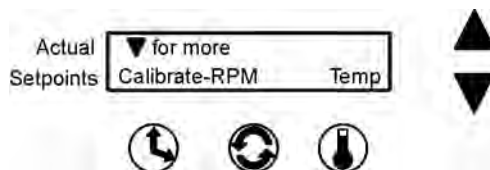

The value shown on this screen is the present speed setpoint. Using the up and down arrows, increase or decrease the platform speed until the reading on an independent, accurate speed measuring device matches the shaker speed setpoint.

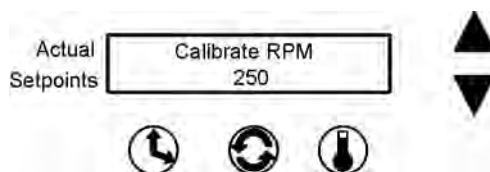

When finished, press the Speed button to save the setting. The display will return to the Calibrate - RPM Temp screen. Or, if nothing is pressed for about fifteen seconds, the display will revert to the Operating Screen and the setting will be automatically saved to memory.

Calibrate the Temperature

After accessing the Configuration menu (above), press the Temperature button beneath Temp.

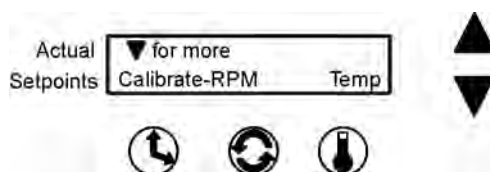

Using the up and down arrows, increase or decrease the temperature value to match an independent, accurate temperature measuring device. When selected, press the Time, Speed, or Temp button to save the setting. The display will return to the Calibrate - RPM Temp screen. (Or, if nothing is pressed for about fifteen seconds, the display reverts to the Operating Screen and the setting is automatically saved to memory.)

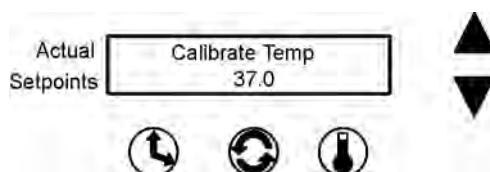

Remote Alarm System

Any of the alarm states described can alert a remote alarm monitoring system through an internal SPDT relay connected to an RJ-11 jack on the rear of the shaker cabinet. Refer also to 'Connect the Remote Alarm' in Section 1. For the convenience of the laboratory, these remote alarms can be individually turned on or off.

Any or all of the remote alarms set to On will activate the internal relay.

Note The Remote Overtemp Shutdown, Platform Stalled and Check Fuse alarms cannot be deactivated. ▲

To set the remote alarms to On or Off, open the Remote Alarm Configuration menu by pressing the down arrow, up arrow, and silence buttons in that sequence. Then, press the down arrow three times until the screen below is showing.

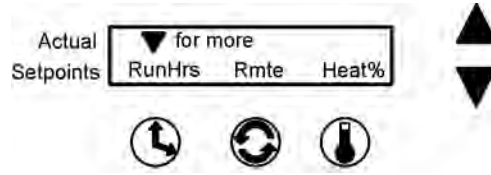
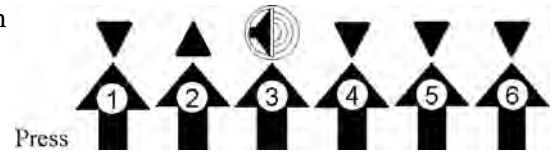

Press Rmte (remote). The alarms will be shown in the following sequence:

Cycle Complete

Toggle the Cycle Complete alarm with either the up (On) arrow or the down (Off) arrow. Pressing the Next (temperature) button advances the display to the next alarm, saving the shown Cycle Complete setting to memory.

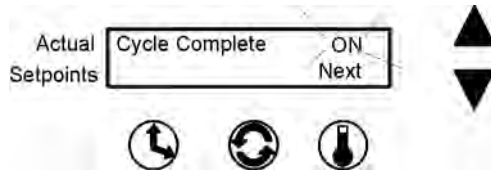

If no buttons are pressed, the display automatically returns to the Operating Screen after about fifteen seconds, saving the selection to memory.

Power Failure

Toggle the Power Failure alarm with either the up (on) arrow or the down (off) arrow. Pressing the Next (temperature) button advances the display to the next alarm, saving the Power Failure setting to memory.

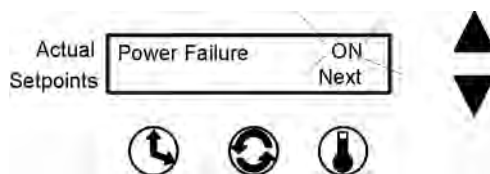

If no buttons are pressed, the display automatically returns to the Operating Screen after about fifteen seconds, saving the selection to memory.

RPM Tracking

Toggle the RPM Tracking alarm with either the up (On) arrow or the down (Off) arrow. Pressing the Next (temperature) button advances the display to the next alarm, saving the RPM Tracking setting to memory.

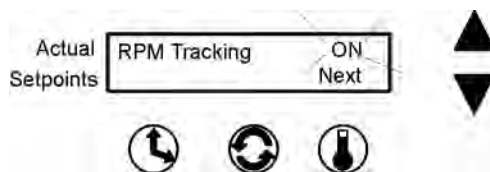

If no buttons are pressed, the display automatically returns to the Operating Screen after about fifteen seconds, saving the selection to memory.

Check Belt

Toggle the Check Belt alarm with either the up (on) arrow or the down (off) arrow. Pressing the Next (temperature) button advances the display to the next alarm, saving the Check Belt setting to memory.

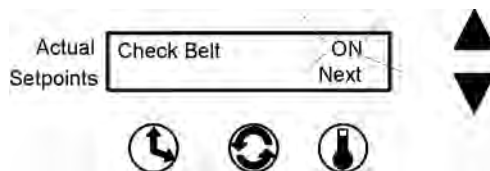

If no buttons are pressed, the display automatically returns to the Operating Screen after about fifteen seconds, saving the selection to memory.

Sensor Fault

Toggle the Sensor Fault alarm with either the up (On) arrow or the down (Off) arrow. Pressing the Next (temperature) button advances the display to the next alarm, saving the on/off setting to memory.

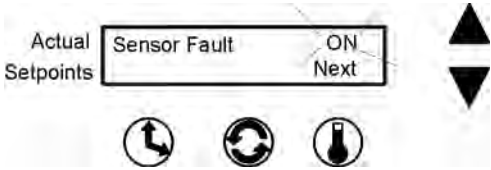

If no buttons are pressed, the display automatically returns to the Operating Screen after about fifteen seconds, saving the selection to memory.

Temperature High or Low

Toggle the Temperature High/Low alarm with either the up (On) arrow or the down (Off) arrow. Pressing the Return (temperature) button advances the display to the display shown below.

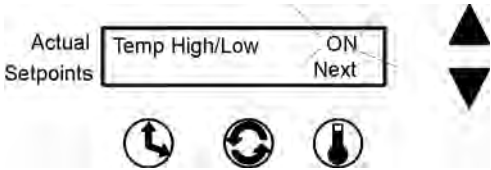

If no buttons are pressed, the display automatically returns to the Operating Screen after about fifteen seconds, saving the selection to memory.

View Total Operating Hours

Whether the shaker has been operated in the hold or countdown modes, and/or has been turned off and unplugged many times, the microprocessor control system maintains a running total operating hours.

To view this information, access the Configuration menu by pressing the down arrow, up arrow and Silence button in sequence, then press the down arrow three times.

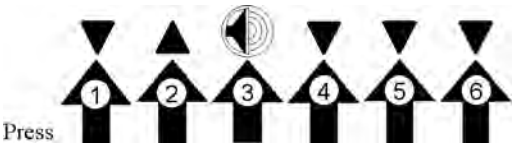

View Total Operating Hours (continued)

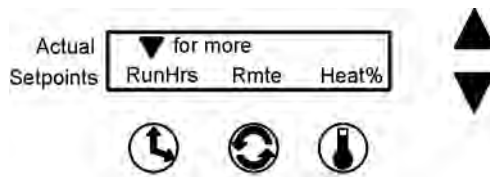

Pressing RunHrs shows the total accumulated run hours as displayed in the illustration below. In about fifteen seconds, the display returns to the Operating Screen.

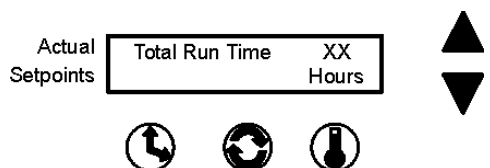

Heat %

Heat percent is intended for factory use only, but can be helpful in troubleshooting the heat control system.

To view this information, access the Configuration menu by pressing the down arrow, up arrow and Silence button in that sequence, then press the down arrow three times.

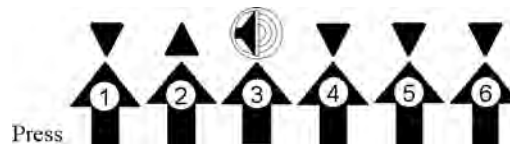

Press Heat %.

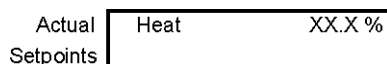

Heat % is the percentage of time that the heater is turned on during a five second period. Example: If the heater is being cycled on for two seconds and off for three seconds, the Heat % value is 40 percent.

Return to RunHrs Rmte Heat% screen by pressing any of the three buttons beneath the display.

If no buttons are pressed, the display automatically returns to the Operating Screen in about fifteen seconds.

Software Version

Software Version is for factory use only and will be important if troubleshooting the microprocessor programming is ever necessary.

To access this screen, press the down arrow, up arrow, Silence button, then the down arrow button four more times.

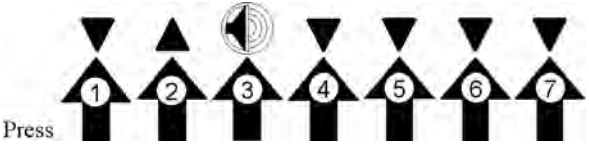

The screen below will appear on the display:

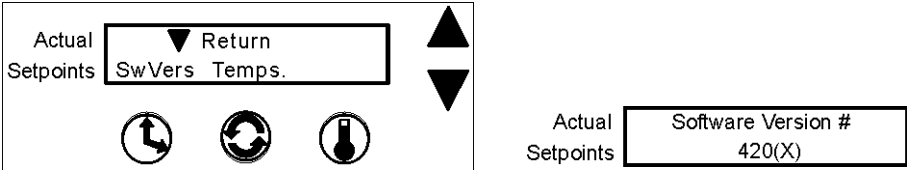

Press the Time button beneath SwVers and the above screen will appear showing the Model 420 software version in the control system memory.

To return to the previous screen, press the Time button. To return to the Operating Screen, wait about fifteen seconds.

Temperature Sensor Readings

Temperature Sensor Readings is for factory use only and will be important if troubleshooting the microprocessor programming is ever necessary.

To access this screen, press the down arrow, up arrow, Silence button, then the down arrow button four more times. The screen shown below will appear on the display:

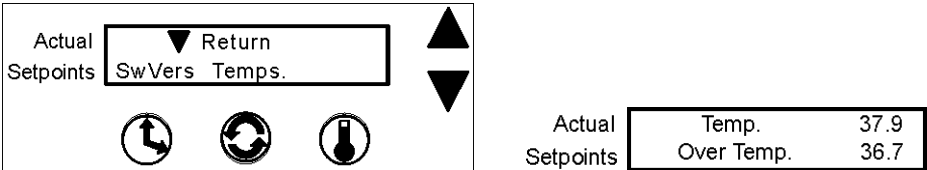
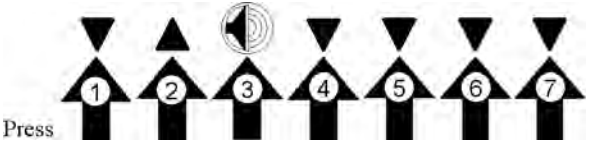

Press the Speed button beneath Temps. and the following screen will appear, showing the temperatures being measured or read by the Main Temperature and the Overtemperature sensors as shown (above).

To return to the previous screen, press the Speed button. To return to the Operating Screen, wait about fifteen seconds.

Model 420 Orbital Shaker Menu Map

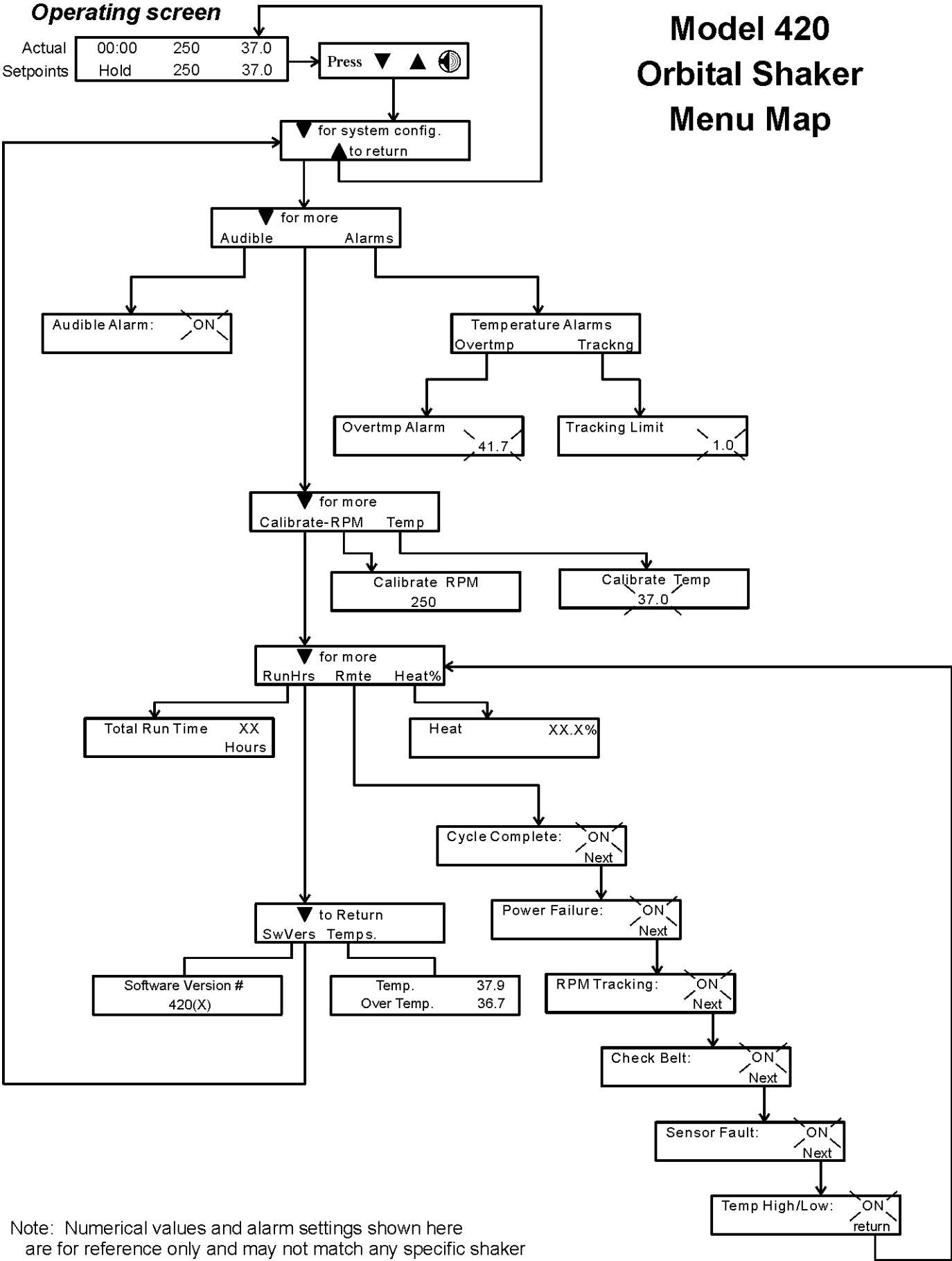

Note: Numerical values and alarm settings shown here are for reference only and may not match any specific shaker

Alarm Message	Alarm Criteria	Alarm Delay*	Alarm Ringback*	System State	Corrective Action
Over Temp Shutdown	Temperature at the over temp sensor is about 1° over shut down set point	None	15 min.	Alarm light on Audible alarm on Blower fans on Shaker motor on Heaters off	Press RESET to silence audible alarm Check for air intake blockage Over temperature probe malfunction Sensor connector unplugged Heater circuit not cycling Main circuit board failure Call the Thermo Forma Service Department.
Main Temp Sensor	Sensor circuit is open or shorted beyond the expected resistance range in either direction	30 sec.	15 min.	Alarm light on Audible alarm on Blower fans on Shaker motor on Heaters off	Press RESET to silence audible alarm Check board connector Check sensor circuit Replace sensor Call the Thermo Forma Service Department.
Over Temp Sensor	Sensor circuit is open or shorted beyond the expected resistance range in either direction	30 sec.	15 min.	Alarm light on Audible alarm on Blower fans on Shaker motor on Heaters on	Press RESET to silence audible alarm Check board connector Check sensor circuit Replace sensor Call the Thermo Forma Service Department.
Temperature is High	Temperature is above control set point by temperature tracking limit	None	15 min.	Alarm light on Audible alarm on Blower fans on Shaker motor on Heaters on	Press RESET to silence audible alarm Check temperature tracking limit Check sensor circuit Replace main temperature sensor Call the Thermo Forma Service Department.
Temperature is Low	Temperature is below control set point by temperature tracking limit	30 min.	15 min.	Alarm light on Audible alarm on Blower fans on Shaker motor on Heaters on	Press RESET to silence audible alarm Check if lid is completely closed Check temperature tracking limit Check sensor circuit Replace main temperature sensor Call the Thermo Forma Service Department.
Power Failure	Electrical power has been disrupted	Upon power up	None	Not affected	Warning notice only Press RESET to silence audible alarm

Alarm Message	Alarm Criteria	Alarm Delay*	Alarm Ringback*	System State	Corrective Action
Cycle Complete	Count-down time has reached zero	None	None	Alarm light on Audible alarm on Blower fans on Shaker motor off Heaters on	Advisory notice only Press RESET to silence alarm
RPM High	RPM is above control set point by tracking limit	2 min.	15 min.	Alarm light on Audible alarm on Blower fans on Shaker motor on Heaters on	Press RESET to silence audible alarm Check platform loading Check RPM tracking limit setting Shut unit off and call Thermo Forma's Service Department.
RPM Low	RPM is below control set point by tracking limit	2 min.	15 min.	Alarm light on Audible alarm on Blower fans on Shaker motor on Heaters on	Press RESET to silence audible alarm Check for overloaded platform Check for obstruction to edges of platform Check for low input AC mains voltage Shut unit off and call Thermo Forma's Service Department.
Check Belt	Rotation sensor circuit sees no mechanical rotation or excessive belt slippage	None	15 min.	Alarm light on Audible alarm on Blower fans on Shaker motor on Heaters on	Press RESET to silence audible alarm Shut the unit off and check the belt If alarm persists, call Thermo Forma's Service Department.
Audible is disabled!	Operator has turned off the audible alarm	None	None	Normal operation	Lower half of the LCD display will show this warning as long as the audible alarm remains turned off
Platform Stalled	Free movement of the platform is obstructed	15 sec.	15 min.	Alarm light on Audible alarm on Blower fans on Motor on/off/on Heaters on	Press RESET to silence audible alarm Check for overloaded platform Check for obstruction to platform edges Turn unit off and call Thermo Forma's Service Department.
Check Fuse	Primary drive motor fuse blown	15 sec.	15 min.	Alarm light on Audible alarm on Blower fans on Shaker motor off Heaters on	Press RESET to silence audible alarm Check/Replace drive motor fuse If alarm persists, call Thermo Forma's Service Department

PREVENTIVE MAINTENANCE

Shakers

Your equipment has been thoroughly tested and calibrated before shipment. Regular preventive maintenance is important to keep your unit functioning properly. The operator should perform routine cleaning and maintenance on a regular basis. For maximum performance and efficiency, it is recommended the unit be checked and calibrated periodically by a qualified service technician.

The following is a condensed list of preventive maintenance requirements. See the specified section of the operating manual for further details.

We have qualified service technicians, using NIST traceable instruments, available in many areas. For more information on Preventive Maintenance or Extended Warranties, please contact us at the number below.

Cleaning and calibration adjustment intervals are dependent upon use, environmental conditions and accuracy required.

Tips for all shakers:

- Use only our standard flat-head screws for flask clips.
- Use only our standard round-head screws for test tube racks, holders and utility trays.

Preventive Maintenance for 420 Series Shakers

Refer to Manual Section	Action	Daily	Monthly	Yearly
--	Clean the unit with mild detergent and wipe dry as needed		✓	
--	Clean the acrylic cover with a dedicated plastic cleaner and wipe dry with lint-free towels		✓	
--	Check under the platform for broken glass or other debris.		✓	
3	* Check and document calibration of temperature, alarms, speed and time, as applicable.			✓
--	* Verify operation of circulation fan motor			✓

* Qualified service technicians only

Section 3 Maintenance

Model 420 Orbital Shaker uses a brushless DC motor and oversized, permanently-lubricated bearings that require no maintenance.

Platform and Cabinet

The anodized brushed aluminum platform and powder-coated steel cabinet surfaces can be cleaned with a mild detergent and water. However, liquids should not be allowed to enter the shaker cabinet from under the platform. All spills should be cleaned up immediately. If necessary, remove the platform. Refer to 'Clean-up After a Spill' below. See Section 1 when re-installing the platform.

Control Panel

The microprocessor control panel has sealed push buttons and a liquid crystal display. It may be cleaned by wiping with laboratory detergents and drying with a soft cloth.

Clean-up After a Spill

If an accidental spill places liquids or other materials under the platform, immediately turn the unit off, unplug it, and remove the platform with the T-handle wrench supplied with the unit. Clean up the spill following regular laboratory procedures. Replace the platform following the procedures in Section 1.

Test Overtemperature Alarm

After every 6,000 hours of operating time, it is recommended that the over-temperature alarm be tested.

1. Set the OverTemp Alarm setpoint at least 20°C above ambient temperature, refer to Section 2 in this manual.
2. Set the shaker operating temperature at least 10°C, but no more than 15°C above ambient. Allow the unit to stabilize at this temperature. To change the operating temperature, refer to Section 2 in this manual.
3. Lower the OverTemp Alarm setpoint to 2°C below the operating temperature setpoint, refer to Section 2 in this manual.
4. Return to the Operating Screen.
5. The alarm lights and audible alarm should come on.
6. The display should read “Overtemp Shutdown.”
7. Press the Silence button to mute the audible alarm if desired.
8. The actual cabinet temperature should drop to just above the OverTemp Alarm setpoint.
9. The alarm lights and audible alarm will momentarily go off as the cabinet temperature drops below the Over Temp Alarm setpoint.
10. Reset the OverTemp Alarm and Operating Temperature setpoints to their original settings.
11. If the shaker control system does not react as outlined above, contact the Technical Services Department at the numbers listed on the service page at the beginning of this manual.

Section 4 Service

Caution The procedures outlined in this section shall be performed by persons experienced in servicing and maintaining laboratory equipment. Lockout and tagout electrical power connections whenever removing cabinet panels or working on electrical or motor control components. ▲

With the exception of replacing the drive v-belt and the six electrical fuses, the Model 420 Orbital Shaker contains no user-serviceable components. The following lists display messages which may help diagnose abnormal conditions.

Alarms and Alarm Conditions

If the microprocessor control system senses a fault, malfunction or abnormal operating condition, alarm messages appears on the liquid crystal display. These messages will be helpful should service or repair assistance be necessary.

Table 4-1. Alarm Indications

Alarm Message	Fault Condition
Overtemp Shutdown	System shutdown due to overtemperature condition
Main Temp Sensor	Temperature sensor has failed
Over Temp Sensor	Temperature sensor has failed
Temperature is High	Temperature tracking has sensed higher temperature than setting
Temperature is Low	Temperature tracking has sensed lower temperature than setting
RPM High	RPM tracking has sensed shaker speed higher than setting
RPM Low	RPM tracking has sensed shaker speed lower than setting
Power Failure	Power has failed during shaker operation
Cycle Complete	Notifies operator that end of countdown cycle has been reached
Check Belt	Motor V-belt has broken or slipped
Audible is Disabled!	Continuously notifies operator that audible alarm has been disabled
Platform Stalled	Free movement of the platform has been obstructed
Check Fuse	Primary drive motor fuse has blown

Table 4-2. General Fault Conditions

Symptom	What to Check and Where to Look
Display is dark, shaker will not operate	Power at the wall outlet Fuses on the back of the unit are blown Power switch not turned on
Display is lit, motor will not operate	Voltage selector switch at wrong position Drive motor fuses inside cabinet are blown Acrylic lid is not closed No time value entered into the system (see Section 2) Time countdown has been reached (see Section 2)
Display is on, motor operates, display shows 7.5°C or over temp state	Faulty temperature sensor Faulty overtemperature sensor
Display is on, motor operates, fan(s) do not run	Blower motor fuses are blown Connections or wires to fan relay board interrupted
Display is on, heat is on but fans and motor do not operate	Voltage selector switch
Display on, unit will not operate (Time reads zero)	Countdown time reached, reset TIME (see Section 2)
Forgot the Access Code	Call Technical Services Department

Adjust Drive V-belt Tension

Tools needed:

Phillips screwdriver

3/8" drive socket wrench with 7/16" socket

1. Remove all connectors and the line cord from the back of the shaker.
2. Lift the front of the shaker and rest it on its back. Remember that the weight of the shaker is 185 pounds (83.9kg).

Warning The shaker is not stable when on its back. A second person may be necessary to support the shaker while in this position. ▲

3. Remove the bottom cabinet cover (8 Phillips screws).

Adjust Drive V-belt Tension (continued)

- Loosen, but do not remove, the three 1/4-20 screws located in the slotted holes adjacent to the shaker drive motor. Refer to Figure 4-1. Internal springs will automatically apply the proper tension against the drive belt.

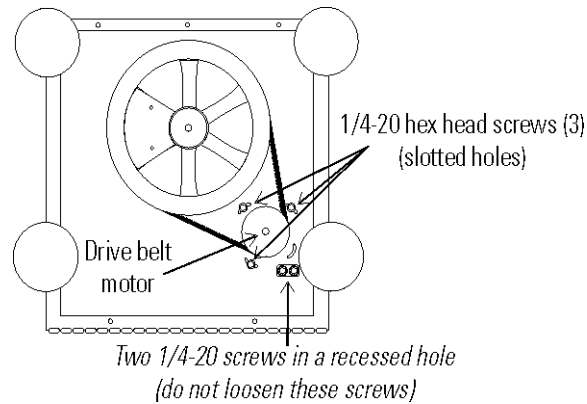

Figure 4-1. Loosen Three Screws

- Tighten the three screws.
- The v-belt is now under proper operating tension.

Warning Tighten all screws. Do not allow the shaker to operate against the spring tension. ▲

Install a New Drive V-belt

Follow the procedures in the steps above to loosen all three 1/4-20 screws.

Warning The drive motor is under spring tension and may suddenly move when the third pivot screw is loosened. When the new belt is installed, tighten all screws. Do not allow the shaker to operate against spring tension. ▲

- Place the new v-belt around the bottom of both the motor and the large drive wheel.
- Force the drive motor inward toward the drive wheel and rotate the drive wheel counterclockwise, forcing the v-belt into the wheel groove. It may be necessary to use a lever (large screwdriver or pry bar) to move the drive motor inward against the spring tension. The large rubber foot can be used to pry against. When the belt is properly seated in the motor and drive wheels, the internal springs apply proper tension.
- Tighten the three screws in the slotted holes.
- Install the bottom cover and return the shaker to service.

Troubleshoot/Replace Circuit Boards

The plastic control panel frame is attached to the cabinet by Velcro strips. Grasp the frame by the corners and pull it off. There are also small indents located along the edges of the panel to accommodate a flat screwdriver blade. The display circuit board is attached to the back of the control panel by ten 6-32 x 3/8" Phillips head screws.

Electronics Panel

All circuit boards (with the exception of the control panel on the front of the unit) are installed on a swing-down electronics panel inside the rear portion of the cabinet.

To access the panel, unplug the shaker and move it to a sturdy location that will allow the back of the cabinet to swing down and lie flat. Remove the screws indicated by the arrows in Figure 4-2 and lower the back panel.

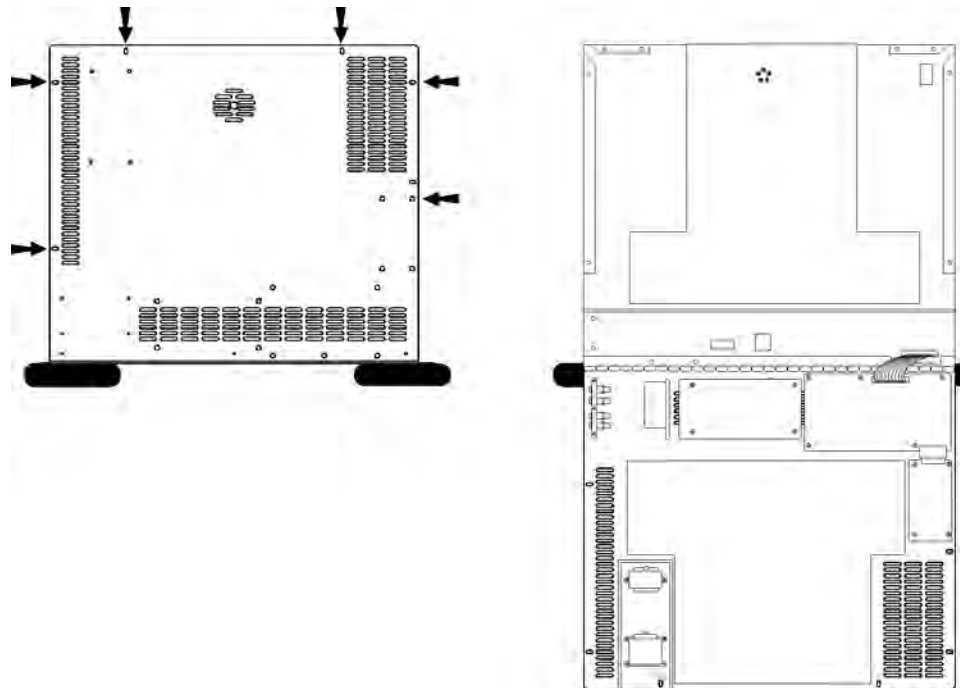

Figure 4-2. Screws to Remove Back Panel

**Electronics Panel
(continued)**

Components in the electronics panel are identified in Figure 4-3. Refer to the parts list and the electrical schematics in the back of this manual for part numbers.

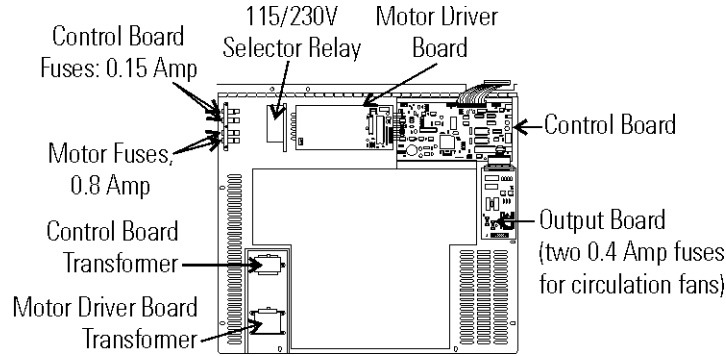

Figure 4-3. Panel Components

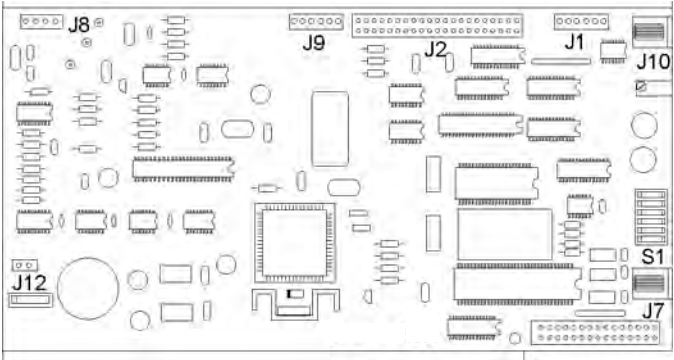

Figure 4-4. Board Components

Table 4-3. Board Pin Connectors

Connector	Description
J1 (pins 1,2)	Lid Open Switch
J1 (pins 3,4)	Baud rate 1200 default, 9600 with pins shorted
J1 (pins 5,6)	Factory test use only
J2	Display panel
J8 (pins 1,2)	Control temperature sensor
J8 (pins 3,4)	Overtemp temperature sensor
J7	RS-232 port
J9	To Motor Driver Circuit Board
J10	Remote alarm contacts
J11	Connector to Output Board
J12	10 VAC in

Output Board

The Output Board is illustrated in Figure 4-5. Fuses F1 and F2 (0.4 Amp) protect the circulating fan circuit.

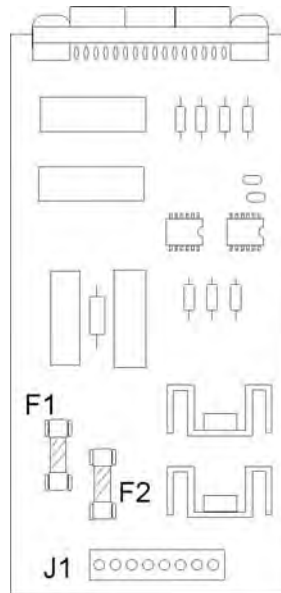

Figure 4-5. Fuse Locations

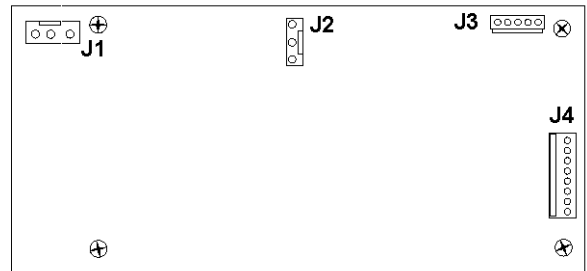

Figure 4-6. Driver Board Connector Locations

Motor Driver Circuit Board

Figure 4-6 shows the locations of the connectors.

Table 4-4 identifies connectors and pins of Motor Driver Circuit Board.

Table 4-4. Connectors and Pins

Connector	Pin No.	Description
J1	1	20VAC in
	2	Ground
	3	20VAC in
J2	1	Phase A out
	2	Phase B out
	3	Phase C out
J3	1	+ 5 volts
	2	HS3
	3	HS2
	4	HS1
	5	Ground
J4	1	PA5
	2	MISO
	3	MOSI
	4	SCK
	5	Ground
	6	Ground
	7	HS4
	8	+ 5 volts

Manual Reset Thermostat

To prevent excessively high temperatures inside the shaker cabinet, if the air circulating fans should fail, a manual-reset thermostat is located adjacent to the heating elements (Figure 4-7). This thermal device will shut off the heaters and must be manually reset. Lower the electronics panel to access this thermostat.

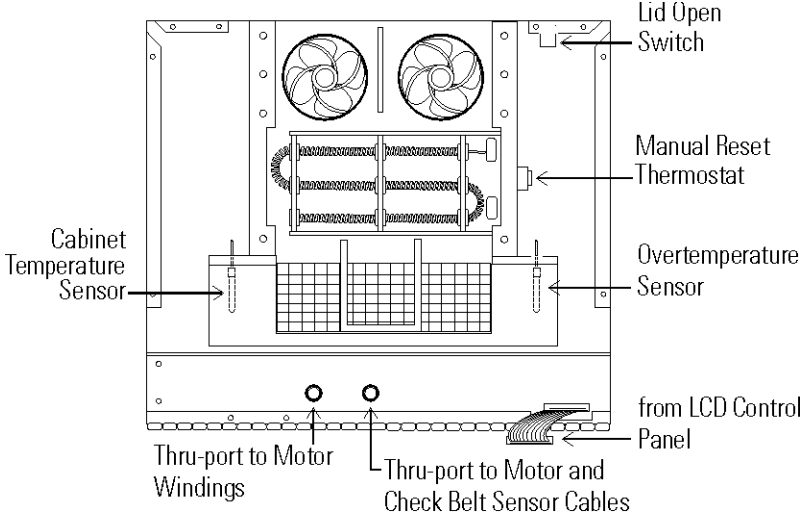

Figure 4-7. Components Behind Electronics Panel

Temperature Sensors

Two sensors, located inside the back of the shaker, are part of the temperature regulating and temperature alarm systems. The location of these sensors is shown in Figure 4-7. Both sensors are wired to a single connector on the Controller Circuit Board. Refer to Figure 4-4. If either of these sensors should fail, an alarm will activate.

Drive Belt Sensor

To alert the operator of a broken drive belt, a sensor is located beneath the drive mechanism. To access this sensor, remove the platform and the sheet metal panel beneath it. Refer to Figure 4-8.

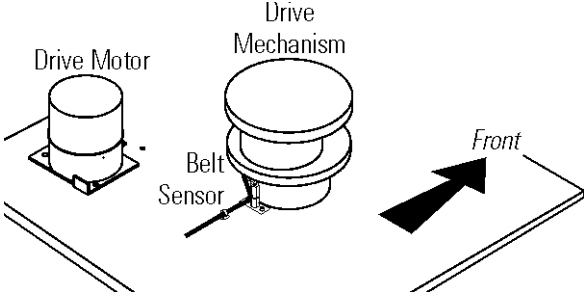

Figure 4-8. Belt Sensor

Spare Fuses

Six spare fuses are provided with this shaker and are taped to the underside of the control panel plastic frame. The plastic frame is attached to the cabinet by Velcro strips. Grasp the frame by the corners and pull to remove. There are also small indents located along the edges of the panel that accommodate a flat screwdriver blade. Figure 4-9 illustrates the underside of the frame.

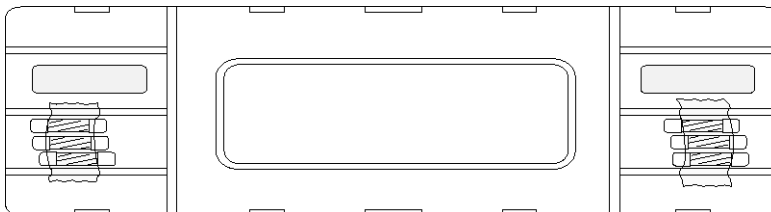

Figure 4-9. Spare Fuse Location

The fuses are:

- 2 each 0.4 amp - circulating fans
- 2 each 0.15 amp - microprocessor control board
- 2 each 0.8 amp - motor driver

For further information about these fuses, see Figure 4-4 and the parts list.

Clean Inside Cabinet After a Major Spill

If liquids or materials have entered the unit through the orbital mechanism hole, the shaker must be disassembled and cleaned immediately. Follow the procedure below.

1. Place the shaker on a sturdy bench or table that will allow the back of the cabinet to be opened and hinged down.
2. Make sure the unit is turned off, unplugged, and the line cord removed from the side of the cabinet. The platform should already be removed.
3. Remove the four screws securing the sheet metal cover plate located under the platform. They are identified with arrows in Figure 4-10. The plate will remain in place.

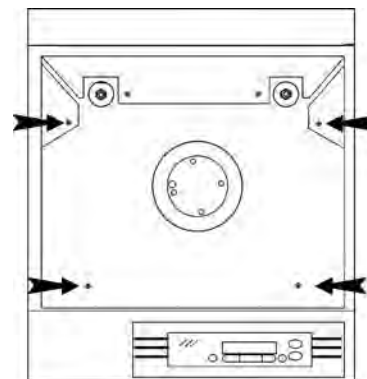

Figure 4-10. Screws Securing Base Plate

Clean Inside After Major Spill (cont.)

4. Remove the six screws securing the back panel, identified with arrows in Figure 4-11. Allow the back of the unit to swing down.

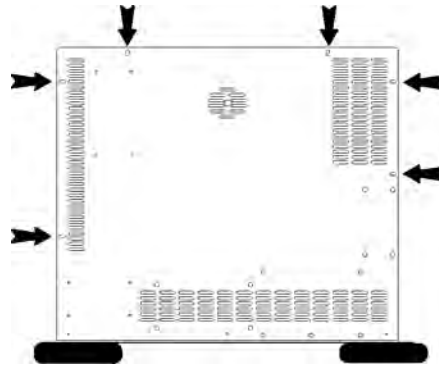

Figure 4-11. Back Panel Screws

5. Remove the four screws identified by the black arrows in Figure 4-12. Disconnect the ribbon connector from J2 of the microprocessor board (white arrow). Also remove the two screws from the ribbon cable cover plate on the base of the cabinet.
6. Remove the wiring connector from J2 of the motor control board (white arrow) and disconnect (separate) the square connector where the wiring enters the base of the unit (also identified by a white arrow in Figure 4-12).

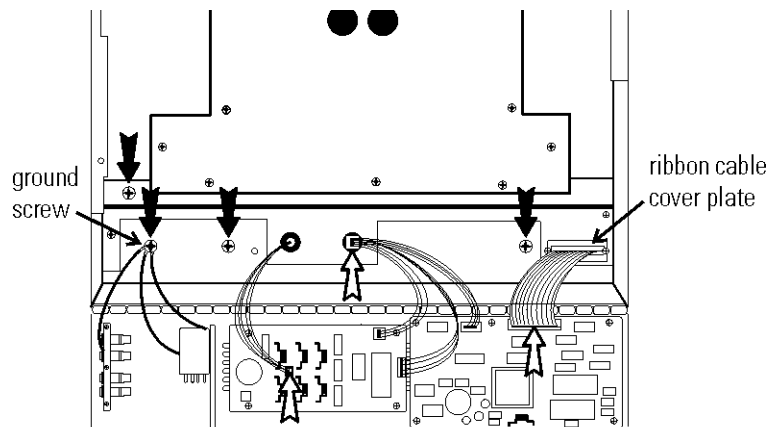

Figure 4-12. Screw and Ribbon Locations

7. Slowly slide the cabinet back and carefully lift it off the base, being careful of the wiring. It will be necessary to feed the ribbon cable through the access hole.

Clean Inside After Major Spill (cont.)

8. The mechanism will be accessible as shown in Figure 4-13.

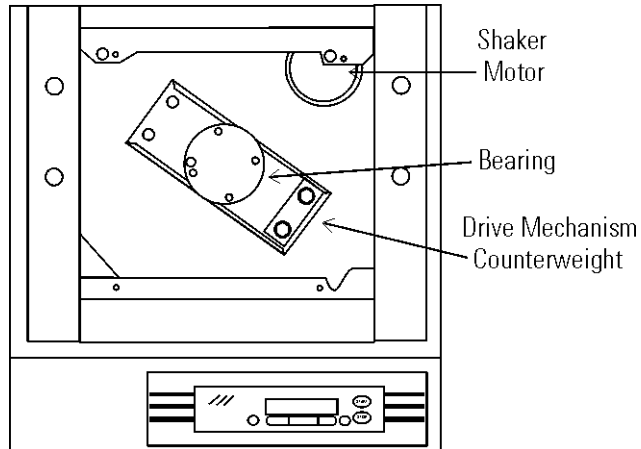

Figure 4-13. Motor, Bearing, and Counterweight Location

9. Clean the mechanism area with a 70% solution of alcohol. Everything must be cleaned, with special attention given to the area around the motor.
10. Allow the unit to air-dry about one hour before reassembling.

Section 5 Specifications

**Specifications are based on nominal voltages of 115V or 230V in ambients of 22°C to 25°C.*

Shaking

Range	25-525 RPM
Accuracy	1 RPM
Motion	One inch per orbit
Indicator	LCD in 1 RPM increments

Temperature

Range	5°C above ambient to 80°C (176°F)
Control Range	0.1°C
Temperature Uniformity	0.2° at 37°C (in flask)
	0.6° at 60°C (in flask)
	1° at 80°C (in flask)

Timer

Set for continuous (hold) operation or set for countdown operation in 5-minute increments from 5 minutes to 200 hours. Timer counts up or down in 5-minute increments.

Alarms

Audible and visual alarms for adjustable tracking high/low RPM, independent platform monitor (check belt), adjustable tracking high/low temperature, independent over temperature, temperature sensor failure, run termination and power failure.

Safeties

Over temperature alarm conditions shuts down heaters, independent platform monitor alarm condition shuts down motor.

LCD Display

40-character LCD readout continuously displays speed in 1 RPM increments, temperature in 0.1°C increments, and time to 5-minute increments.

Microprocessor

Non-volatile memory retains all programming and automatically restarts in the event of a power failure, controlled acceleration provides smooth start up and stopping.

Drive Motor

1/3 HP brushless DC, permanently lubricated ball bearing

Cover

Hardened acrylic, dual gas spring cylinder assisted

Construction

InteriorCold rolled steel

ExteriorCold rolled steel

Finish . . . Powder coated for a durable, easily maintained surface

PlatformAnodized brushed aluminum

Dimensions

Exterior4.3" W x 20.9" H x 29.0" F-B
.(61.7cm x 53.1cm x 73.7cm)

Exterior (lid open) .4.3" W x 35.7" H x 29.0" F-B
.(61.7cm x 90.7cm x 73.7cm)

Interior0.6" W x 12.6" H x 20.5" F-B
.(52.3cm x 32.0cm x 52.1cm)

Electrical

Nominal . . .115 VAC, 50/60 Hz, 1 PH, 6.5 FLA,
Operating Range: 90 - 125 VAC

Nominal . . .230 VAC, 50/60Hz, 1 PH, 3.2 FLA,
Operating Range: 180 - 253 VAC

Data OutputRS-232 standard

Remote Alarm Contacts . . Time, RPM, Temperature and Power Failure
Alarms

Certification

ULStandard 3101-1

CSAStandard C22.2 No. 1010

CE MarkIEC 1010 and EMC

Capacity

Flasks from (49) 25ml up to (6) 2L

Weights

Net185 lbs. (83.9kg)

Shipping266 lbs. (120.7kg)

Optional Platforms

Size18" x 17-3/4" (45.7cm x 45.1cm)

Clips . . .25ml, 50ml, 125ml, 250/300ml, 500ml, 1l, and 2l

Ambient Operating Conditions - For indoor use only

Temperature10°C (50°F) to 40°C (104°F)

Humidity20% to 80%, non-condensing

Sound LevelNot to exceed 85db

Safety Specifications

Altitude - 2,000 meters

Temperature - 10°C to 40°C

Humidity - 20% to 80%, non-condensing

Mains Supply Fluctuations - Operating Voltage Range

Installation Category II ¹

Pollution Degree 2 ²

Class of Equipment I

¹ Installation category (overvoltage category) defines the level of transient overvoltage that the instrument is designed to withstand safely. It depends on the nature of the electricity supply and its overvoltage protection means. For example, in CAT II which is the category used for instruments in installations supplied from a supply comparable to public mains such as hospital and research laboratories and most industrial laboratories, the expected transient overvoltage is 2500V for a 230V supply and 1500V for a 120V supply.

² Pollution Degree describes the amount of conductive pollution present in the operating environment. Pollution Degree 2 assumes that normally only non-conductive pollution such as dust occurs with the exception of occasional conductivity caused by condensation.

Section 6 Parts List

**All parts, with the exception of approved fuses, must be obtained from manufacturer, or its authorized dealers or service representatives.*

Part No.	Description
129034	Pneumatic Spring, 30 lbs.
103079	U-channel gasket for acrylic cover, front
103080	U-channel gasket for acrylic cover, left side
103081	Gasket for acrylic cover, right side
900117	Tubaxial Fan, 106 CFM, 115 V
138010	Heater, Wirewound, 600 W, 115V/230V
156089	Motor, Brushless 24V
191535	Motor Driver Board
190816	LCD Display Panel
190594	Output Board
190802	Microprocessor Control Board
230141	Fuse, 800MA, T.D. 5 x 20 mm, Drive Transformer UL198G
230149	Fuse, 400MA, T.D. 5 x 20 mm, Circulation Fans UL198G
230142	Fuse, 150MA, T.D. 5 x 20 mm, Control Transformer UL198G
285306	Pushbutton Switch, SPDT (lid open)
290160	Probe, 2252 OHM/25C, 1/8 x 2
290144	Sensor, 5VDC 4MA, Hall Effect, Check Belt
400113	Thermostat
420064	Transformer, 130VA
420085	Transformer, 25VA
230165	Fuse, 4A, Type T, IEC, 5 x 20mm, Main Power In, 230V
285633	Fuse, 10A, normal blow, 1/4" x 1-1/4" Main Power In, 115V
800040	V-Belt, AX43, 1/2" x 45"
435051	Screwdriver, Phillips 8-3/4"
443020	Wrench, Hex with T-handle
194046	Spare Part Screw Bag, (platform/clips ¹)

¹ Platform clips are provided by the manufacturer.

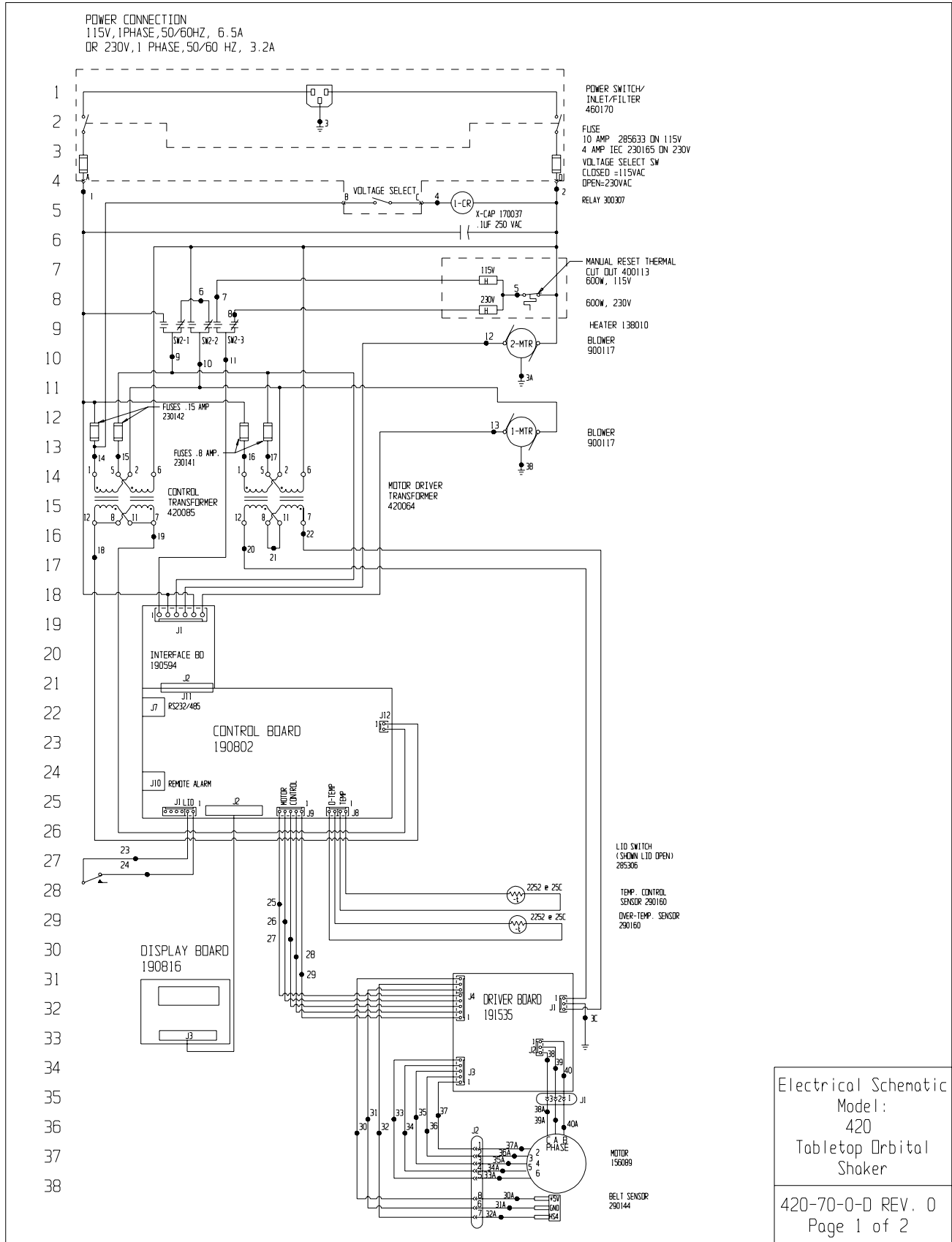

Electrical Schematic
Model:
420
Tabletop Orbital
Shaker
420-70-0-D REV. 0
Page 1 of 2

Section 7
Electrical Schematics

39
40
41
42
43
44
45
46
47
48
49
50
51
52
53
54
55
56
57
58
59
60
61
62
63
64
65
66
67
68
69
70
71
72
73
74
75

WIRE REFERENCE CHART

WIRE #	GAUGE	COLOR	WIRE #	GAUGE	COLOR
1	18	BLACK	30	24	RED
2	18	WHITE	30A	24	RED
3	18	GRN/YEL	31	24	BLACK
3A-3C	18	GRN/YEL	31A	24	BLACK
4	18	ORANGE	32	24	GREEN
5	18	BROWN	32A	24	GREEN
6	18	RED	33	24	BROWN
7	18	ORANGE	33A	24	BROWN
8	18	YELLOW	34	24	WHITE
9	18	BLUE	34A	24	WHITE
10	18	PURP	35	24	GREEN
11	18	BROWN	35A	24	GREEN
12	18	ORANGE	36	24	RED
13	18	RED	36A	24	RED
14	18	RED	37	24	BLACK
15	18	ORANGE	37A	24	BLACK
16	18	YELLOW	38	18	RED
17	18	BROWN	38A	18	RED
18	22	BROWN	39	18	WHITE
19	22	BLUE	39A	18	WHITE
20	18	RED	40	18	BLACK
21	18	ORANGE	40A	18	BLACK
22	18	RED			
23	22	BLACK			
24	22	BLACK			
25	24	BLACK			
26	24	RED			
27	24	GRN			
28	24	WHITE			
29	24	BROWN			

 **ATTENTION**
OBSERVE PRECAUTIONS
ELECTROSTATIC
SENSITIVE DEVICES

THIS DOCUMENT CONTAINS PROPRIETARY INFORMATION AND SUCH INFORMATION IS NOT TO BE DISCLOSED TO OTHERS FOR ANY PURPOSE NOR USED FOR MANUFACTURING PURPOSES WITHOUT WRITTEN PERMISSION FROM THERMO ELECTRON

Thermo
ELECTRON CORPORATION
Controlled Environment Equipment
Box 649, Marietta, Oh 45750

REV	0	05-279	02-11-04	BOB	pkd	CCS	RELEASED FOR PRODUCTION
			DATE	BY	CAD	APPD	DESCRIPTION OF REVISION
MODEL/PART NAME: 420 TABLE TOP SHAKER / INCUBATOR							
DWG TITLE: ELECTRICAL SCHEMATIC							
Dwn:	pkd	CAD:	pkd	APPD:	DATE:	02-11-04	SCALE: NONE
MATERIAL: N/A							
PAINT COLOR: N/A							
TOLERANCE UNLESS OTHERWISE SPECIFIED				DRAWING NUMBER		SIZE	
ANGLES: DECIMAL: .XX±				420-70-0		D	

Electrical Schematic
Model:
420
Tabletop Orbital
Shaker

420-70-0-0 REV. 0
Page 2 of 2

THERMO FISHER SCIENTIFIC ORBITAL SHAKER WARRANTY USA

The Warranty Period starts two weeks from the date your equipment is shipped from our facility. This allows shipping time so the warranty will go into effect at approximately the same time your equipment is delivered. The warranty protection extends to any subsequent owner during the warranty period.

During the first two years or 12,000 hours of use, whichever comes later, component parts proven to be non-conforming in materials or workmanship will be repaired or replaced at Thermo's expense, labor included. In addition, after the initial warranty period of two years or 12,000 hours, the Orbital Shaker mechanism is warranted for Unit Production Life, parts only, F.O.B. factory. The mechanism is defined as the bearing assemblies. Unit Production Life is defined as the period of time the current mechanism design is in production, plus seven years. The warranty will be void if the equipment is altered without written authorization from Thermo. The 12,000 hours use must be validated by the internal timer and/or objective documentation. If validation or documentation of run hours are not available, unit warranty defaults to 3 years, parts and labor. Installation and calibration is not covered by this warranty agreement. The Technical Services Department must be contacted for warranty determination and direction prior to performance of any repairs. Expendable items, i.e., glass, filters, light bulbs and lid gas-kets are excluded from this warranty.

Replacement or repair of components parts or equipment under this warranty shall not exceed the warranty to either the equipment or to the component part beyond the original warranty period. The Technical Services Department must give prior approval for return of any components or equipment.

THIS WARRANTY IS EXCLUSIVE AND IN LIEU OF ALL OTHER WARRANTIES, WHETHER WRITTEN, ORAL, OR IMPLIED. NO WARRANTIES OF MERCHANTABILITY OR FITNESS FOR A PARTICULAR PURPOSE SHALL APPLY. Thermo shall not be liable for any indirect or consequential damages including, without limitation, damages relating to lost profits or loss of products.

Your local Thermo Sales Office is ready to help with comprehensive site preparation information before your equipment arrives. Printed instruction manuals carefully detail equipment installation, operation, and preventive maintenance.

If equipment service is required, please call your Technical Services Department at 1-888-213-1790 (USA and Canada) or 1-740-373-4763. We're ready to answer any questions on equipment warranty, operation, maintenance, service and special applications. Outside the USA, contact your local distributor for warranty information.



Rev. 2 2/07

THERMO FISHER SCIENTIFIC INTERNATIONAL ORBITAL SHAKER WARRANTY

The Warranty Period starts two months from the date your equipment is shipped from our facility. This allows shipping time so the warranty will go into effect at approximately the same time your equipment is delivered. The warranty protection extends to any subsequent owner during the warranty period.

During the first two years or 12,000 hours of use, whichever comes later, component parts proven to be non-conforming in materials or workmanship will be repaired or replaced at Thermo's expense, excluding labor. The orbital shaker mechanism is warranted for life, parts only, F.O.B. factory. The mechanism is defined as the bearing assemblies. Life is defined as the period of time the current mechanism design is in production, plus seven years. The warranty will be void if the equipment is altered without the written authorization from Thermo. The 12,000 hour use must be validated by the internal timer and/or objective documentation. If validation or documentation of run hours are not available, unit warranty defaults to 3 years, parts only. Installation and calibration is not covered by this warranty agreement. Expendable items, i.e., glass, filters, light bulbs and lid gaskets are excluded from this warranty.

Replacement or repair of component parts or equipment under this warranty shall not exceed the warranty to either the equipment or to the component part beyond the original warranty period. The Technical Services Department must give prior approval for return of any components or equipment.

THIS WARRANTY IS EXCLUSIVE AND IN LIEU OF ALL OTHER WARRANTIES, WHETHER WRITTEN, ORAL, OR IMPLIED. NO WARRANTIES OF MERCHANTABILITY OR FITNESS FOR A PARTICULAR PURPOSE SHALL APPLY. Thermo shall not be liable for any indirect or consequential damages including, without limitation, damages relating to lost profits or loss of products.

Thermo International Sales Office is ready to help with comprehensive site preparation information before your equipment arrives. Printed instruction manuals carefully detail equipment installation, operation, and preventative maintenance.

If equipment service is required, please call your Technical Services Department at 740-373-4763, or Fax 740-373-4189. We're ready to answer your questions on equipment warranty, operation, maintenance, service and special applications. Outside the USA, contact your local distributor for warranty information.



Rev. 2 2/07

Declaration of Conformity

Manufacturer's Name: Thermo Fisher Scientific (Asheville) LLC
Manufacturer's Address: 401 Millcreek Road
Marietta, Ohio 45750
U.S.A.
Product Description: Forma® Orbital Shaker
Product Designations: 420
Year of Initial Marking (CE): 1998
Affected Units: Release 6
(Release Level [REL#] shown on Serial Tag)

This product conforms to the following European Union Directive(s):

EMC: 89/336/EEC
LVD: 73/23/EEC

This product conforms to the following Harmonized, International and National Standards:

EMC:	LVD:
EN 61326-1:1997	EN 61010-1:1993
EN 50081-1:92	Amendments 1 and 2
EN 50082-1:97	CSA C22.2 No. 1010.1
	UL 61010A-1

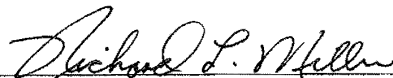
Richard L. Miller, CQE
Regulatory Compliance Manager

ThermoFisher
S C I E N T I F I C

05 February 2007

Rev. 3

Thermo Fisher Scientific
Controlled Environment Equipment
401 Millcreek Road
Marietta, Ohio 45750
United States

www.thermofisher.com